

СІМЕ ЗАІРПАІР ОІНІІР



arturo alvarez
emotional light



Emotional

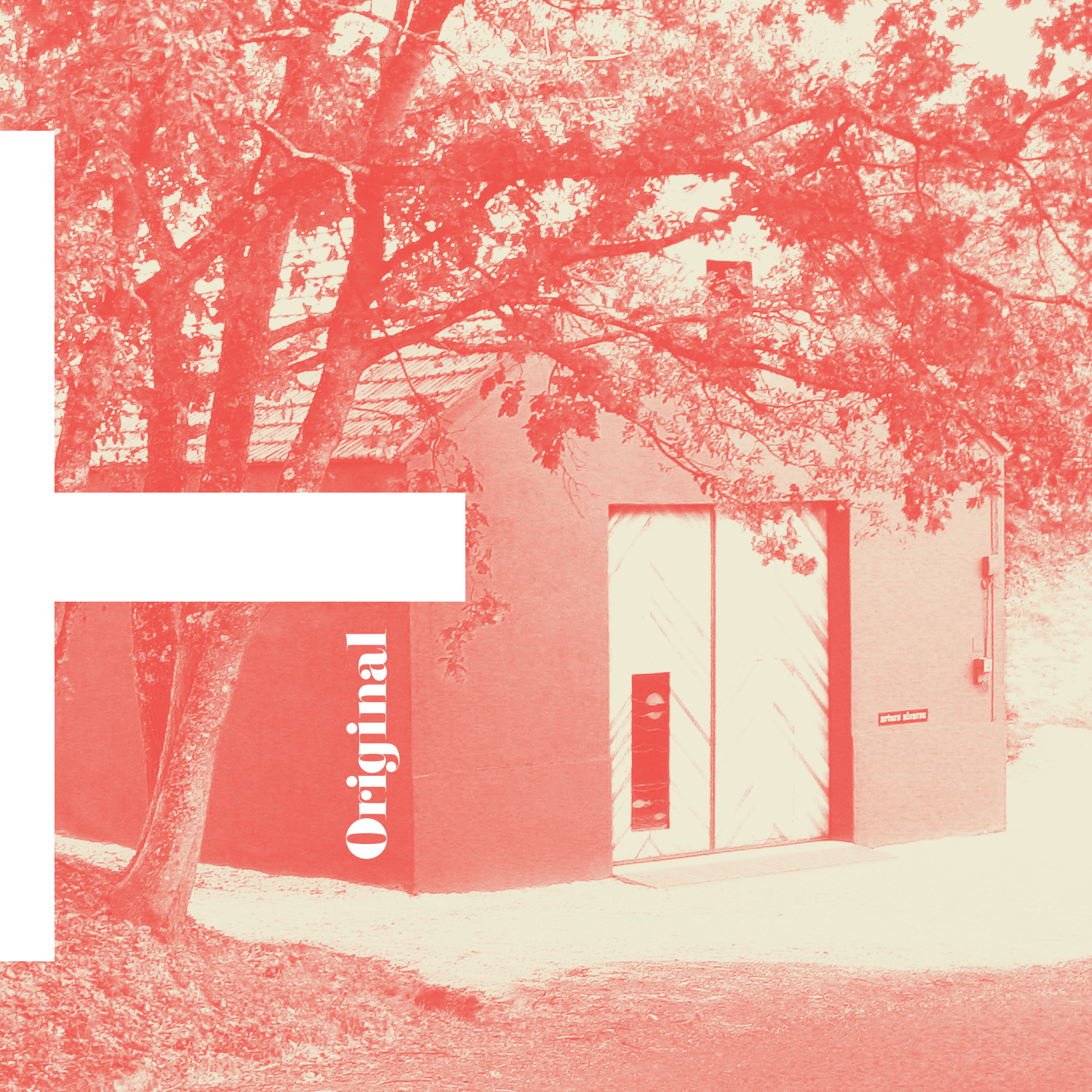

Original

original design

A close-up photograph of a hand holding a stack of papers. The papers have a marbled pattern. The entire image is overlaid with a semi-transparent red filter. A white rectangular box is positioned on the right side of the image, containing the word "Handcrafted" in a bold, black, serif font.

Handcrafted

Natural

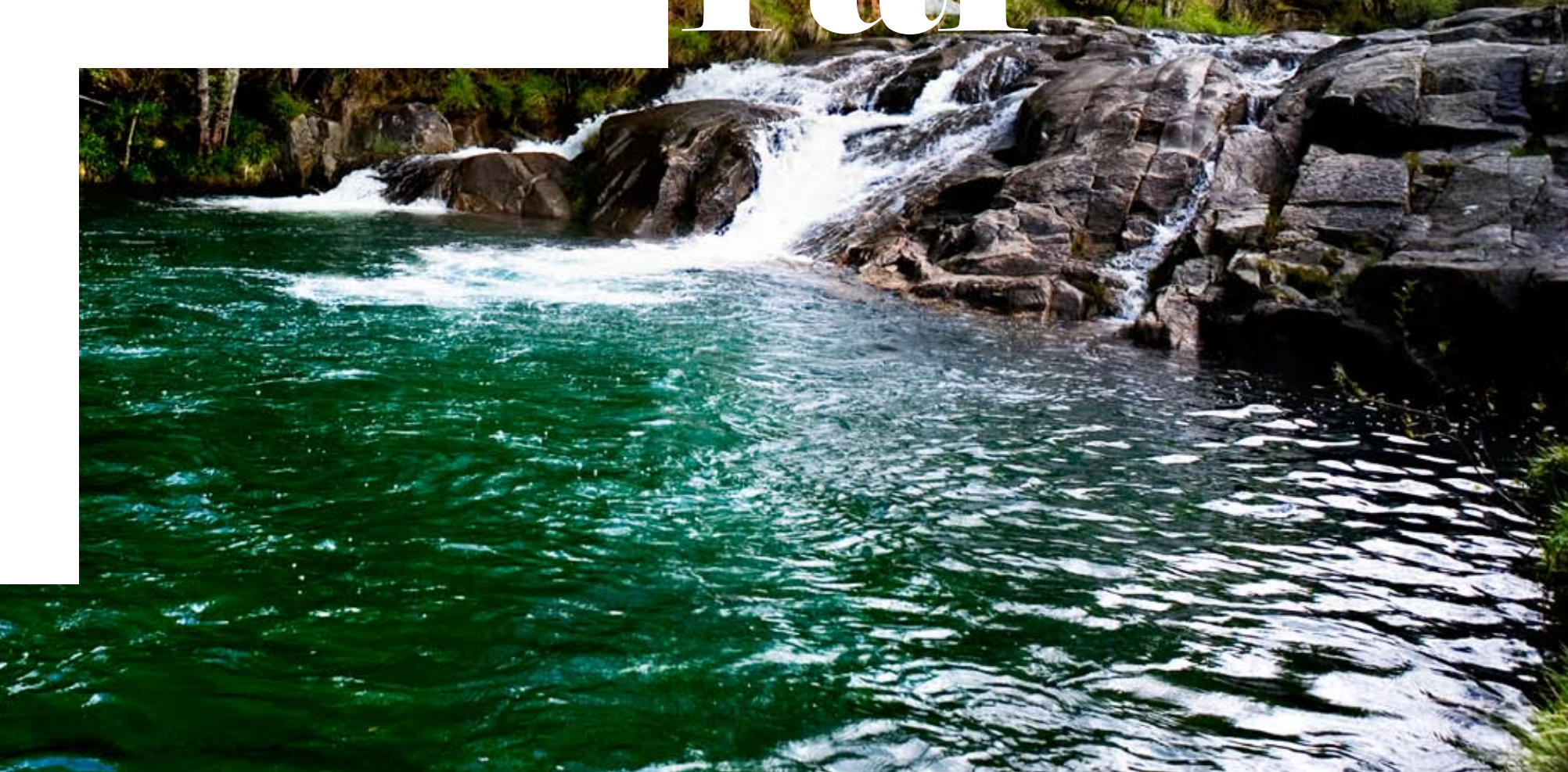

10

Coral

22

Muu

34

Planum

40

Le

26

Nevo

44

v

52

Li

58

64

Gea

70

Cors

74

Kala

78

Kite

Tati

82

Vento

88

92

Shio

Gluc

98

Tina

102

Guau

106

Iki

112

Norr

114

Miuu

120

Rhizome

122

Bety

128

Woods

134

Uxi

138

Hexa

140

Fluo

142

Curvas

150

Holes

152

Norman

156

Lua

146

Aros

160

Diseñadores
Designers

164

Directorio técnico
Technical directory

190

Leyenda de Símbolos
Symbol Index

191

Créditos
Credits



Co- real

An organic look for a collection of wrap-around and warm luminaires that refer us to the origins of life, the sea. Shapes that remind us of the beauty and richness of coral reefs.

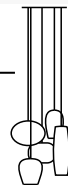

**Co04-5**Composición *Composition*↔ 80cm 31^{1/2} in ↓ 95 cm 37^{1/2} in ↗ 80cm 37^{1/2} in ↑ 250cm 98^{1/2} in



Co04-3 Composición *Composition*
↔70cm 27^{3/4} in ↓68 cm 27 in ↗70cm 27^{3/4} in ↑250cm 98^{1/2} in

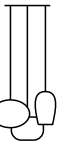





Co04-10 Composición *Composition*
↔135cm 53^{1/4} in ↓123cm 48^{1/2} in ↗135cm 53^{1/4} in ↑250cm 98^{1/2} in

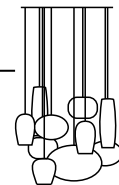

De aspecto orgánico, esta colección de luminarias envolventes y cálidas nos remite al origen de todo lo vivo, al mar.

Formas que nos recuerdan la belleza y riqueza de los arrecifes coralinos.





CoAu04 Colgante *Pendant Lamp*
Ø 44 x 30 cm 17^{1/2} x 12 in ↓ 150 cm 96 in

CoAu04G Colgante *Pendant Lamp*
Ø 70 x 41 cm 27^{3/4} x 16^{1/4} in ↓ 150 cm 96 in



CoCy04 Colgante *Pendant*
 ∅ 30 x 30 cm 12 x 12 in
 ↓ 150 cm 96 in

CoRe04 Colgante *Pendant*
 ∅ 20 x 60 cm 8 x 23^{3/4} in
 ↓ 150 cm 96 in

CoSe04 Colgante *Pendant*
 ∅ 35 x 25 cm 14 x 10 in
 ↓ 150 cm 96 in

CoGa04 Colgante *Pendant*
 ∅ 25 x 37 cm 10 x 14^{3/4} in
 ↓ 150 cm 96 in

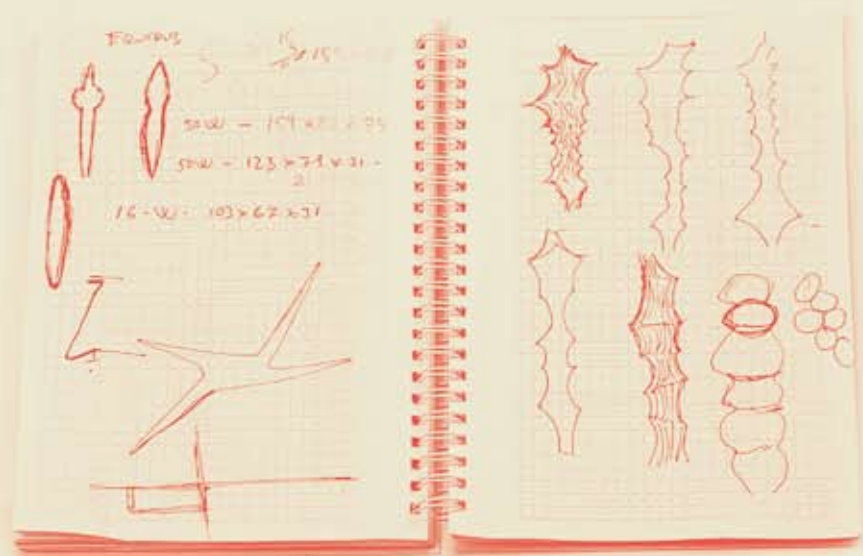
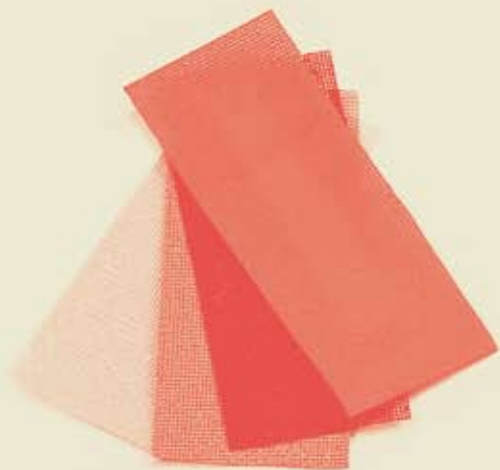



Design

Primeras ideas, bocetos que surgen y adquieren vida propia, que cambian y se adaptan a las reflexiones. Cálculos, pruebas, nace un prototipo, el germen de un nuevo diseño.

Preliminary outlines, sketches that arise and take on their own life, that change and adapt to later thoughts. Calculations, tests, a model, it is born the germ of a new design.



Muuu



Mu01 Sobremesa *Table Lamp*
↔30,5 cm 12 in ↓36 cm 14^{1/4} in ↗8 cm 3^{1/4} in

Mu02 Sobremesa *Table Lamp*
↔41,5 cm 16^{1/2} in ↓47 cm 18^{1/2} in ↗10 cm 4 in

Estas lámparas de mesilla en dos tamaños se inspiran en la naturaleza y los animales con los que trabajan las gentes del campo. Es un homenaje, un tributo, a su duro trabajo siempre en la sombra y sin ningún reconocimiento.

These table lamps, available in two sizes, are inspired by nature and the animals which the countrymen work with. It is a tribute to their unrecognized hard work always staying in the background.





Nevo

Industrial



Una forma viva que parece en constante evolución. Una nube de curvas sugerentes, de volúmenes imposibles en la que el futuro se entrelaza con el presente de forma sutil. Una forma desacomplejada trabajada con materiales de última generación.

A vibrant shape that seems to be constantly changing. A cloud of suggestive curves, of impossible volumes where the future intersects with the present in a subtle way. A self-confident shape made of cutting-edge materials.

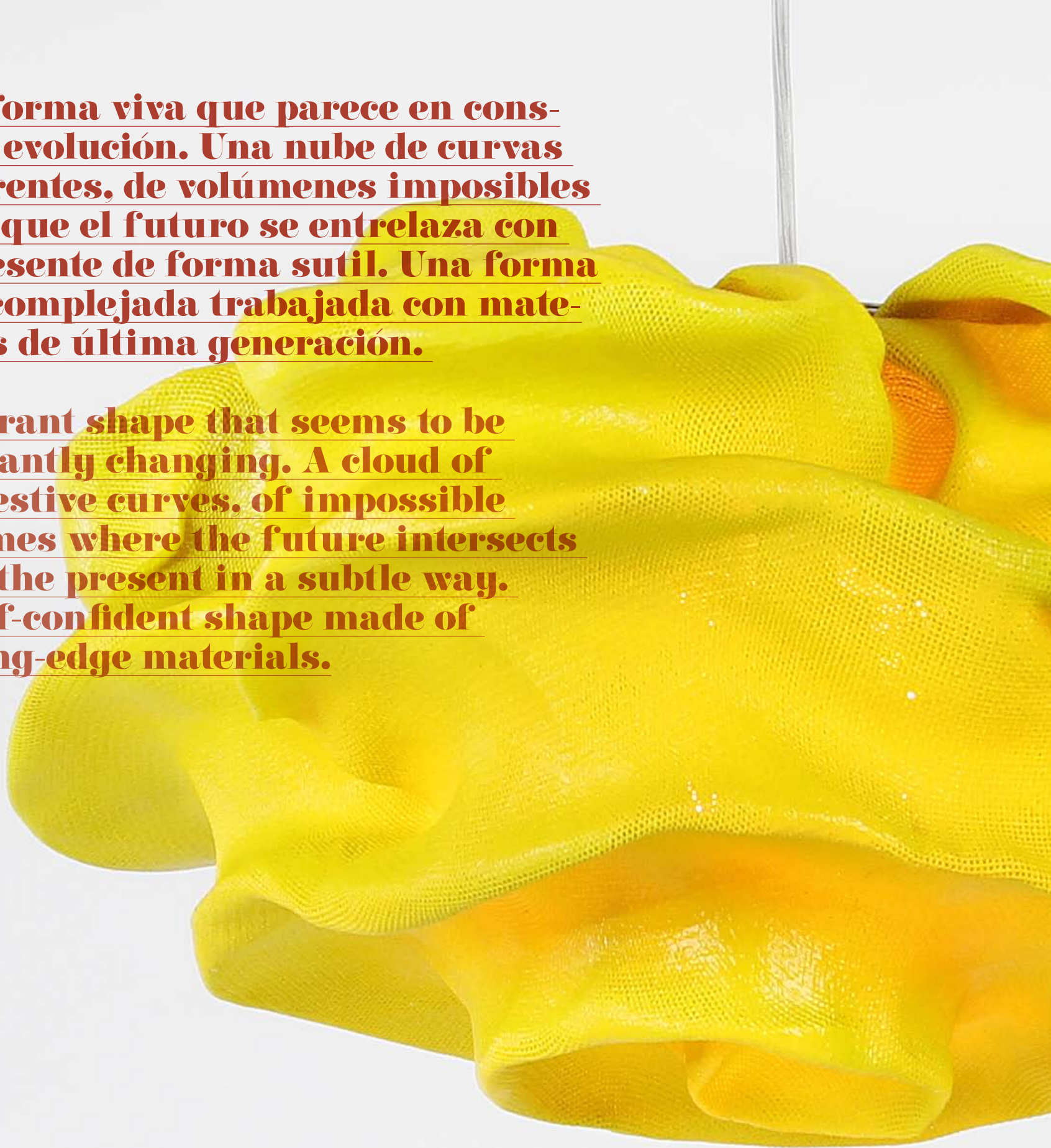

Ne04 Colgante *Pendant*
Ø65 x 25 cm 25^{3/4} x 10 in 1150 cm 96 in

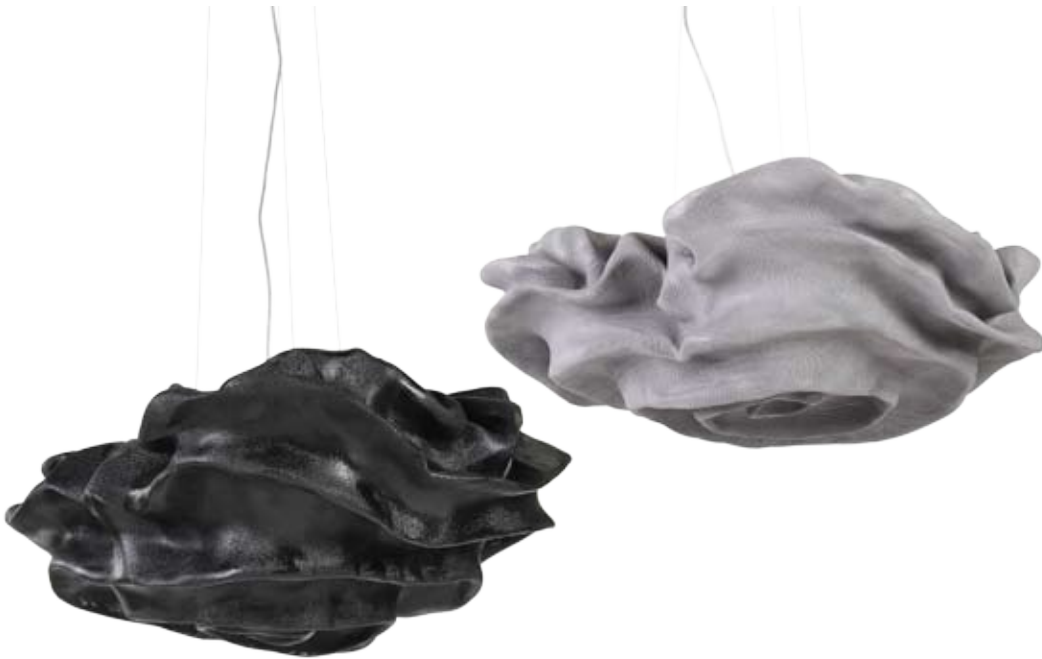

Ne04-1 Colgante *Pendant*
Ø44 x 22 cm 17^{1/2} x 8^{3/4} in 1150 cm 96 in



Ne04G Colgante *Pendant*
Ø100 x 30 cm 39^{1/2} x 12 in 1200 cm 96 in





Ne02
Lámpara de Mesa *Table Lamp*
Ø 44 x 22 cm 17^{1/2} x 8^{3/4} in H 70 cm 27^{3/4} in





Ne06 Aplique / Plafón Wall / Ceiling Lamp
 Ø 44 cm 17^{1/2} in ↗ 22 cm 8^{3/4} in



Ne06P Aplique / Plafón Wall / Ceiling Lamp
 Ø 32 x 35 cm 12^{3/4} x 13^{3/4} in ↗ 20 cm 7^{3/4} in

Pla-
num



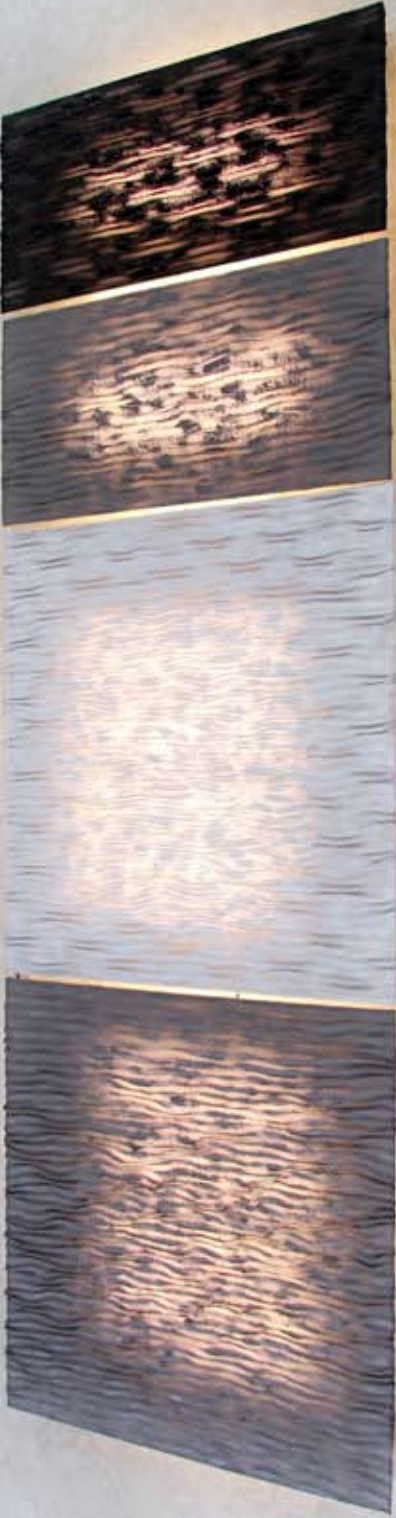

**Una pantalla
que nos permite
cubrir grandes
superficies con
una luz cálida y
agradable.**

**A lampshade
that lets us cover
large surfaces
with a warm and
pleasant light.**



**Delicadas formas planas con pequeños y sutiles
relieves que nos permiten crear auténticos cielos
de luz en ambientes arquitectónicos.**

**Delicate shapes with small and subtle texture
that let us create authentic skies of light in
architectural atmospheres.**

**Pm06PR**

Aplique / Plafón *Wall / Ceiling Lamp*
↔ 47 cm 18^{3/4} in ↑ 96 cm 38 in ↗ 8 cm 3^{1/4} in



Pm06R Aplique / Plafón Wall / Ceiling Lamp
↔ 96 cm 38 in 196 cm 38 in 78 cm 3 1/4 in

Le

DESIGNED BY
Arturo Álvarez

El pie recuerda
ramas de árbo-
les, a partir de
tablero marino,
se juntan de for-
ma caprichosa,
pero con una
proporción calcu-
lada. Una forma
simple, que como
una rama al vien-
to, se mueve de
muy diferentes
maneras.

The base re-
minds of tree
branches made
in plywood. They
get together in a
fanciful shape
but with a calcu-
lated proportion.
A simple sha-
pe that, like a
branch to the
wind, moves on
different ways.



Un brazo móvil permite diferentes movimientos. El pie poniéndolo vertical da una luz ambiental y si lo colocamos horizontal ofrece luz para mesa de trabajo o lectura. La tecnología Led aprovechada en todo su potencial.

A mobile arm allows different movements. Putting the base in vertical gives an ambience light and in horizontal a working or reading desk light. Led technology made the most of itself.

Le03 Lámpara de Pie *Floor Lamp*
↔ 150 cm 59¹/₄ in ↓ 150 cm 59¹/₄ in
↗ 65 cm 25³/₄ in ↑ 185 cm 73 in





Una forma espacial, pero cercana y posible, que nos emociona y con la que nos identificamos, a través de lo extraordinario y fantástico.

A spatial shape, yet near and tangible, that thrills and inspires a sense of identity through the extraordinary and fantastic.

DESIGNED BY
Héctor Serrano







A través de la tecnología de inyección de plástico se consigue una familia de luminarias que a través de sus lamas, combinadas de forma geométrica, nos sumergen en un mundo onírico.

Vv04G

Colgante *Pendant Lamp*
∅ 105 x 29 cm 41^{1/2} x 11^{1/2} in † 200 cm 96 in

Vv04

Colgante *Pendant Lamp*
∅ 80 x 29 cm 31^{1/2} x 11^{1/2} in † 150 cm 96 in

With the help of the plastic injection technology we developed a lighting collection which, through its ribs combined with the geometrical form, immerses us in a world of dreams.





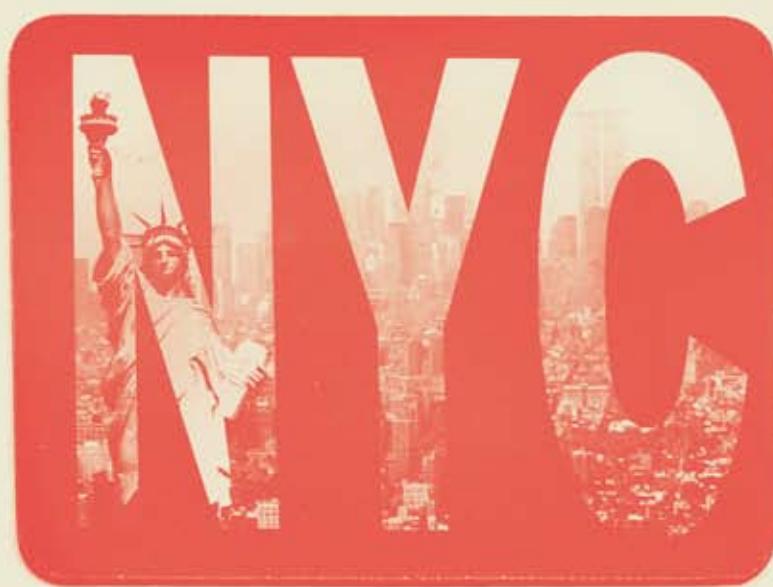

Sales

Trabajamos para las personas y sus necesidades. Somos como hormigas, cada una en su puesto, dando lo mejor de sí, para ofrecer en cada momento lo que el todo más global nos demande.

*We work for people and their needs.
We operate a little like ants, each doing our best in our position in order to offer whatever the global world asks for.*





Li

DESIGNED BY
Arturo Álvarez

Tiras de pasta de celulosa prensada robustas y resistentes. Surge de una técnica ancestral. Usado, entre otros, como material de embalaje en Japón desde el siglo XVI. Se obtiene de reciclado ecológico. La luz led utilizada completa y profundiza el concepto de sostenibilidad.

Strong and resistant pressed cellulose stripes. They emerge from ancestral techniques. Not only, but used in Japan as packaging material since 16th century. Ecological recycling systems are used. LED lighting rounds off and goes more deeply into the concept of sustainability.









Líneas discontinuas y curvadas, que semejan suaves olas en el mar, bañan las paredes con sutileza, unas formas delicadas y amables que dejan escapar la luz que se asoma entre las tiras para reflejarse en la pared.

Look-alike waves broken curved lines drench walls in subtlety, fine and delicate shapes that let light beams out in order to lean out of the stripes to be reflected on the wall.



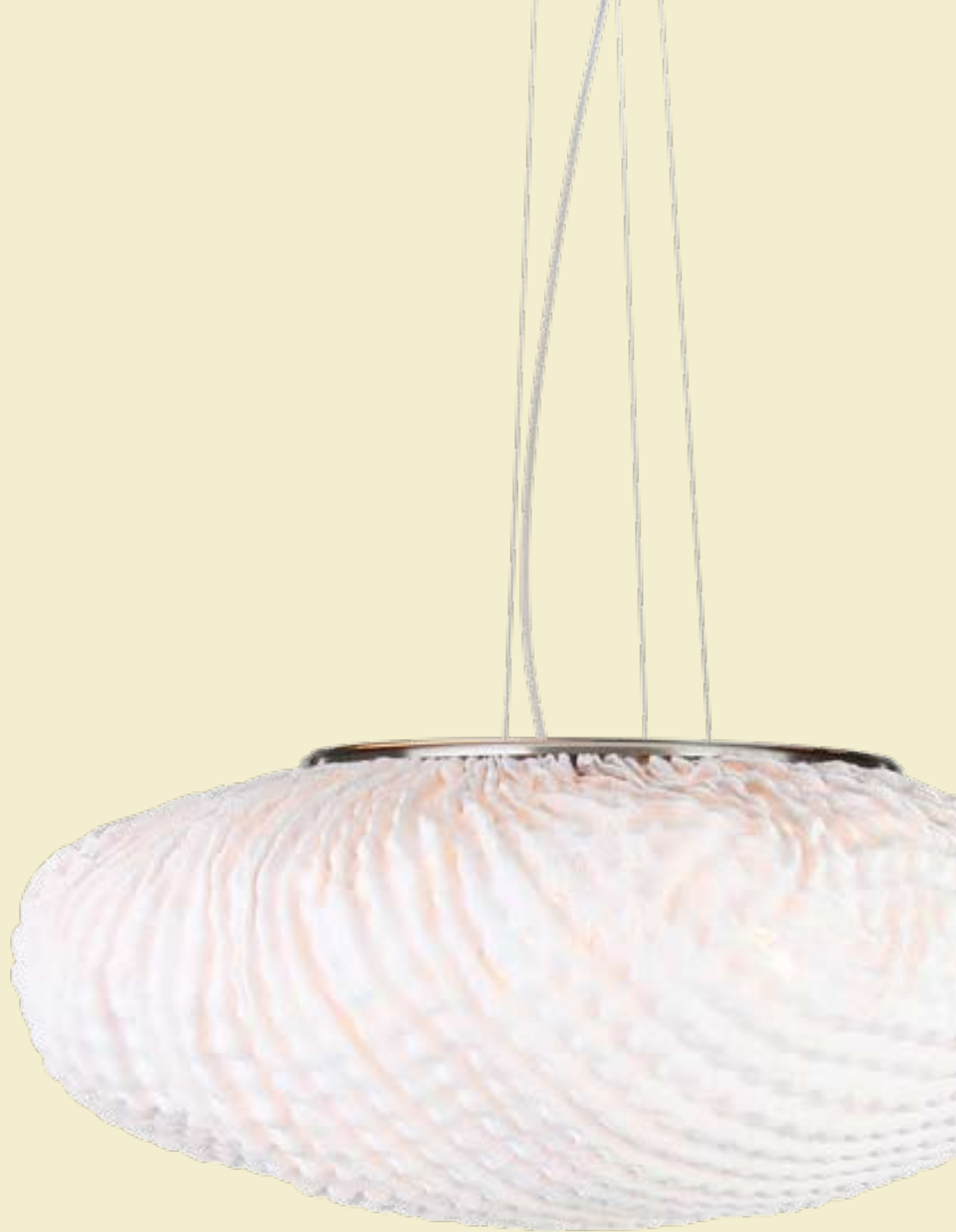

Tati

Ta02 Lámpara de Mesa *Table Lamp*
Ø40 x 20 cm 15^{3/4} x 8 in 165 cm 25^{1/2} in



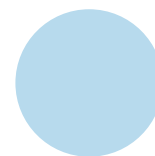
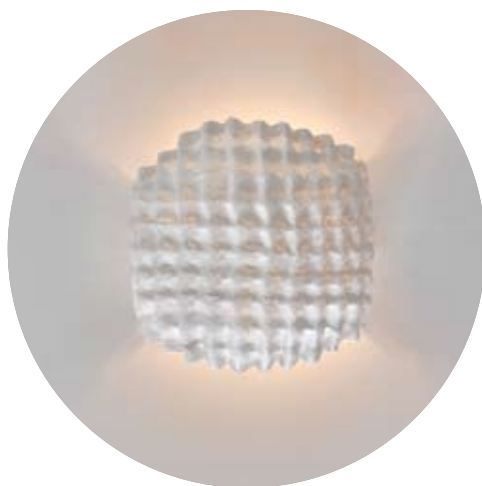
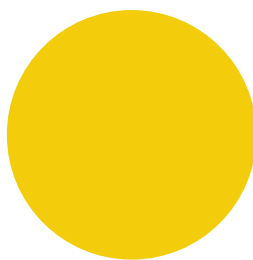

Ta06G Aplique/Plafón *Wall/Ceiling Lamp*
 ↓40 cm 15^{3/4} in ↔40 cm 15^{3/4} in ↗22 cm 8^{3/4} in

Ta06 Aplique/Plafón *Wall/Ceiling Lamp*
 ↓22 cm 8^{3/4} in ↔20 cm 8 in ↗13 cm 5^{1/4} in

Ta06P Aplique/Plafón *Wall/Ceiling Lamp*
 ↓30 cm 12 in ↔30 cm 12 in ↗17 cm 6^{3/4} in



Una forma redondeada,
con una textura tejida
en torno a círculos que
se repiten formando
una piel, un caparazón.
Volvemos la mirada a
la simetría de la natu-
raleza recreada.



Vista desde Arriba
 Top View

Ta04 Colgante *Pendant Lamp*
 †22 cm 8^{3/4} in ↔55 cm 21^{3/4} in †150 cm 96 in

Ta04-1 Colgante *Pendant Lamp*
 †22 cm 8^{3/4} in ↔45 cm 17^{3/4} in †150 cm 96 in

Ta04G Colgante *Pendant Lamp*
 †34 cm 13^{1/2} in ↔92 cm 36^{1/4} in †150 cm 96 in



A round shape with a texture woven into circles that repeat themselves to make up a skin, a shell.
We turn our gaze at the simmetry of recreated nature.

GED





A sinuous shape that provides indirect enveloping light.
A lamp that fills spaces with a soft and pleasant light.
It is easy to combine and has the ability to blend in any type of environment.

Detalle Cremallera
Zip Detail

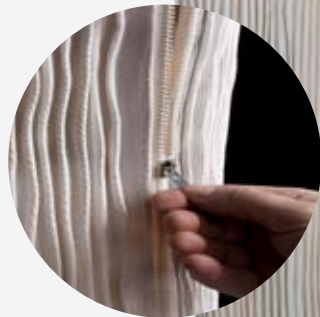





Ge06 Aplique Wall Lamp
↔16 cm 6^{1/2} in ↓26 cm 10^{1/4} in ↗13 cm 5^{1/4} in



Una forma
sinuosa que
proporciona
una luz
indirecta y
envolvente.
Una pieza que
llena los esp-
acios de una luz
suave y agrada-
ble, fácilmente
combinable y
que se mimetiza
en cualquier
ambiente.



Cors



La mujer siempre presente, envuelta en sofisticación y misterio. Unas curvas que lucen todo su esplendor y que dejan entrever un cuerpo luminoso y bello.

Woman always present, surrounded by sophistication and mystery. Such magnificent curves shine and suggest us a glittering and lovely body.







Kiala



KL06 Applique Wall Lamp
↔ 23 cm 9^{1/4} in ↓ 25 cm 10 in ↙ 15 cm 6 in

Líneas discontinuas, un volumen irregular de aspecto vivo y en movimiento, que nos recuerda los dibujos cambiantes de la arena en las grandes dunas.

Broken lines, an irregular volume of moving and living appearance that reminds us of the changing drawings made by the sand on the great dunes.



Kiite

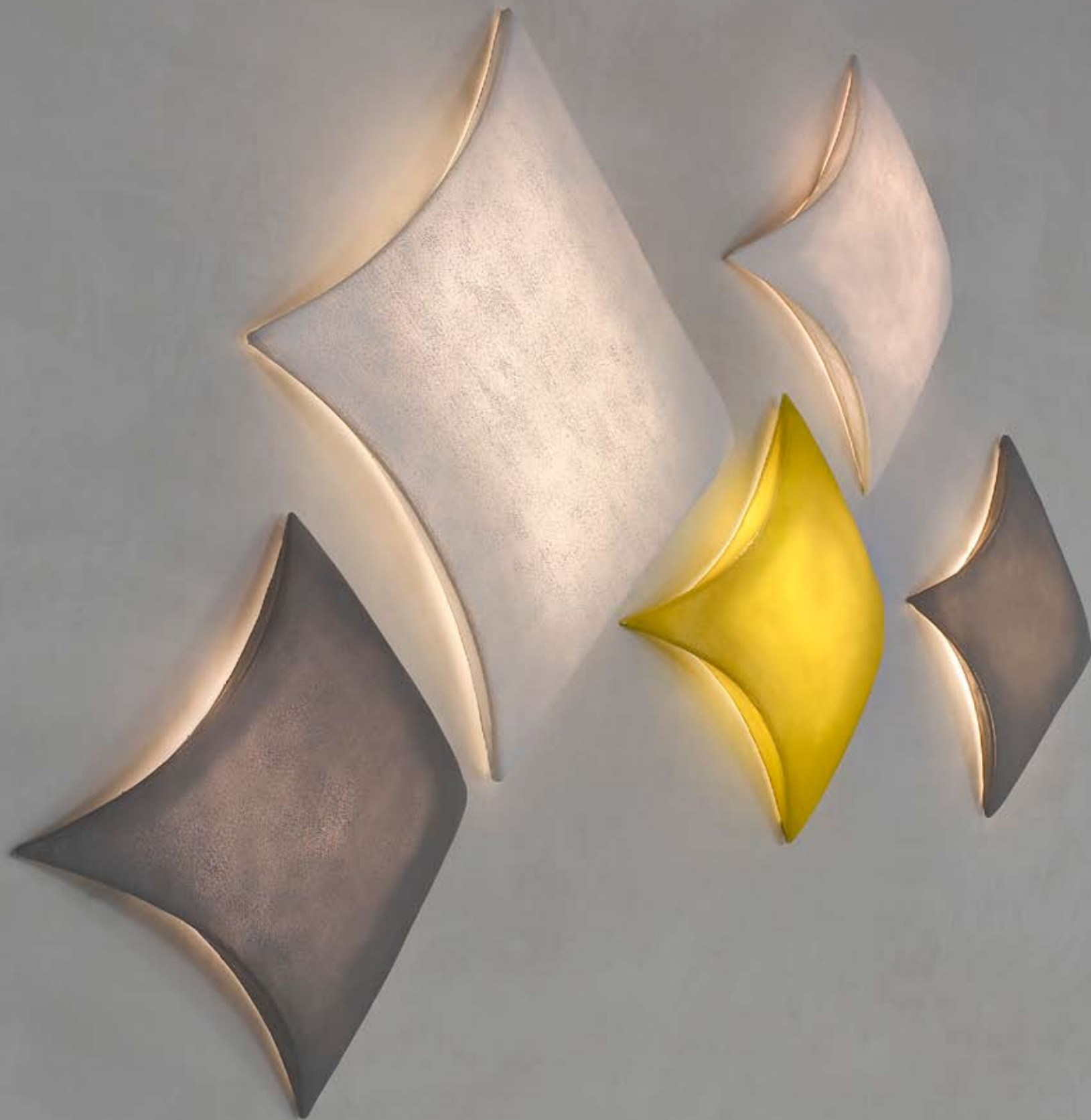

K106 Aplique/Plafón Wall/Ceiling Lamp
↑87 cm 34^{1/4} in ↔ 94 cm 37 in ↗9 cm 3^{3/4} in

K106G Aplique/Plafón Wall/Ceiling Lamp
↑123 cm 48^{1/2} in ↔ 138 cm 54^{1/2} in ↗9 cm 3^{3/4} in





Dos formas curvilíneas e irregulares visten paredes y techos de forma caprichosa pero controlada. Como si se tratara de cometas en el cielo, llenan el espacio de una luz alegre y cálida.

Two irregular and curvaceous forms dress the walls and ceilings in a whimsical but controlled way. As kites in the sky, they fill the space with a warm and joyful light.



Vn04 Lámpara Colgante *Pendant Lamp*
↔ 96 cm 38 in ↑ 17 cm 6^{3/4} in ↙ 19 cm 7^{1/2} in ↑ 150 cm 96 in

Vento



EDICIÓN
EXCLUSIVA
Y LIMITADA

LIMITED &
EXCLUSIVE
EDITION

Vn04Pop

Colgante *Pendant Lamp*
↔96 cm 38 in 117 cm 6^{3/4} in ↗19 cm 7^{1/2} in ↑150 cm 96 in



Un movimiento sinuoso como un viento suave que mece los árboles. Una forma que combina suaves curvas para crear una lámpara contundente. Un modelo en el que se reúnen placidez y sensación de calma gracias a su forma y a la mezcla de colores.

A sinuous movement like a soft breeze that rocks the trees. A shape that combines soft curves to create a powerful lamp. A model that mingles placidity and the sensation of serenity, thanks to its shape and mix of colours.





Vn01 Sobremesa *Table Lamp*
↔58 cm 23 in ↑18 cm 7^{1/4} in ↗16 cm 6^{1/2} in



Vn02pop Sobremesa *Table Lamp*
↔96 cm 38 in ↓21 cm 8^{1/2} in ↗20 cm 8 in



Arturo Álvarez se propone hacer un homenaje al Arte Pop. Esta colección está inspirada en la rebeldía de este movimiento, remover materiales y colores de su contexto habitual para construir otros diferentes que sorprendan.

Arturo Álvarez intends to honour pop art. This collection is inspired in a time of rebellious movements, the defiance to remove materials from its usual context and to construct other different ones which can surprise.



Gluc



Una colección lúdica, divertida y alegre que nos remite a las formas y colores de los años setenta. Un conjunto de burbujas que aporta soluciones lumínicas muy variadas para uso doméstico y comercial.





A flashy, fun and cheerful collection that reminds us of the shapes and colours of the 70's. A set of bubbles that provides diverse lighting solutions for both residential and commercial use.

Shino





Sh03 Lámpara de Pie *Floor Lamp*
ø52 cm 20^{1/2} in 1140 cm 55^{1/4} in



Sh04 Colgante *Pendant Lamp*
Ø49 x 16,5 cm 19^{1/2} x 6^{1/2} in ↓150 cm 96 in

Sh04-1 Colgante *Pendant Lamp*
Ø34 x 13 cm 13^{1/2} x 5^{1/4} in ↓150 cm 96 in



Una forma universal, amable, unida a la belleza del nuevo uso dado al tablero marino, una sucesión de líneas con curva que dan fuerza y dinamismo a una colección versátil y cálida.

A universal shape, gentle, combined with the beauty of a new use given to plywood, a sequence of layers in a curved shape giving power and dynamism to a warm and multi-purpose collection.







DESIGNED BY
Arturo Álvarez

Tina

Ta03 Lámpara de Mesa *Table Lamp*
 ← 80 cm 31½" ↓ 70 cm 27½" ↑ 160 cm 63" in



Tiras de polipropileno de distintas medidas se trabajan para crear unos volúmenes irregulares y armónicos, consiguiendo tamizar la luz entre sus distintas capas para aportar una luz cálida con su fuente de luz oculta.

Different sizes of polypropylene strips are moulded to create irregular and harmonic volumes, softening the light between its different layers and contributing to a warm light with its hidden light source.



Tn04 Colgante *Pendant Lamp*
↔80 cm 31^{1/2}in ↓70 cm 27^{1/2}in ↑150 cm 96in

Tn04G Colgante *Pendant Lamp*
↔80-90 cm 31^{1/2}-35^{1/2}in ↓100 cm 39^{1/2}in ↑150 cm 96in



Guaui

DESIGNED BY
El Último Grito



reddot design award
winner 2010

Lab

Todo sencillez, dos discos de metal tratado y pintado con un juego de rótula y piezas metálicas que permiten abatimientos y rotaciones que confieren gran funcionalidad a la pieza.

Full of simplicity, two treated and painted metal disks with a knuckle joint and metal pieces which allow rotations and up and downs so to give larger versatility to the piece..

La fascinación de los claroscuros: la luz que juega con el observador, que encandila, que se mueve, que gira y que crea un magnetismo lleno de magia a su alrededor.

The fascination of the chiaroscuro, light that plays with the observer, charming them, moving, spinning and creating magnetism full of magic all around.





ilisi

DESIGNED BY
Arturo Álvarez

Envolvente, suave y lúdica.
Un ser orgánico, vivo, amable, que invita a ser tocado y observado. Su interior misterioso y oculto por momentos es traslúcido y brillante.

Wraparound, soft and fun.
An organic, living, and kind being that invites you to touch and observe it. Its dark and mysterious interior at times is transparent and bright.

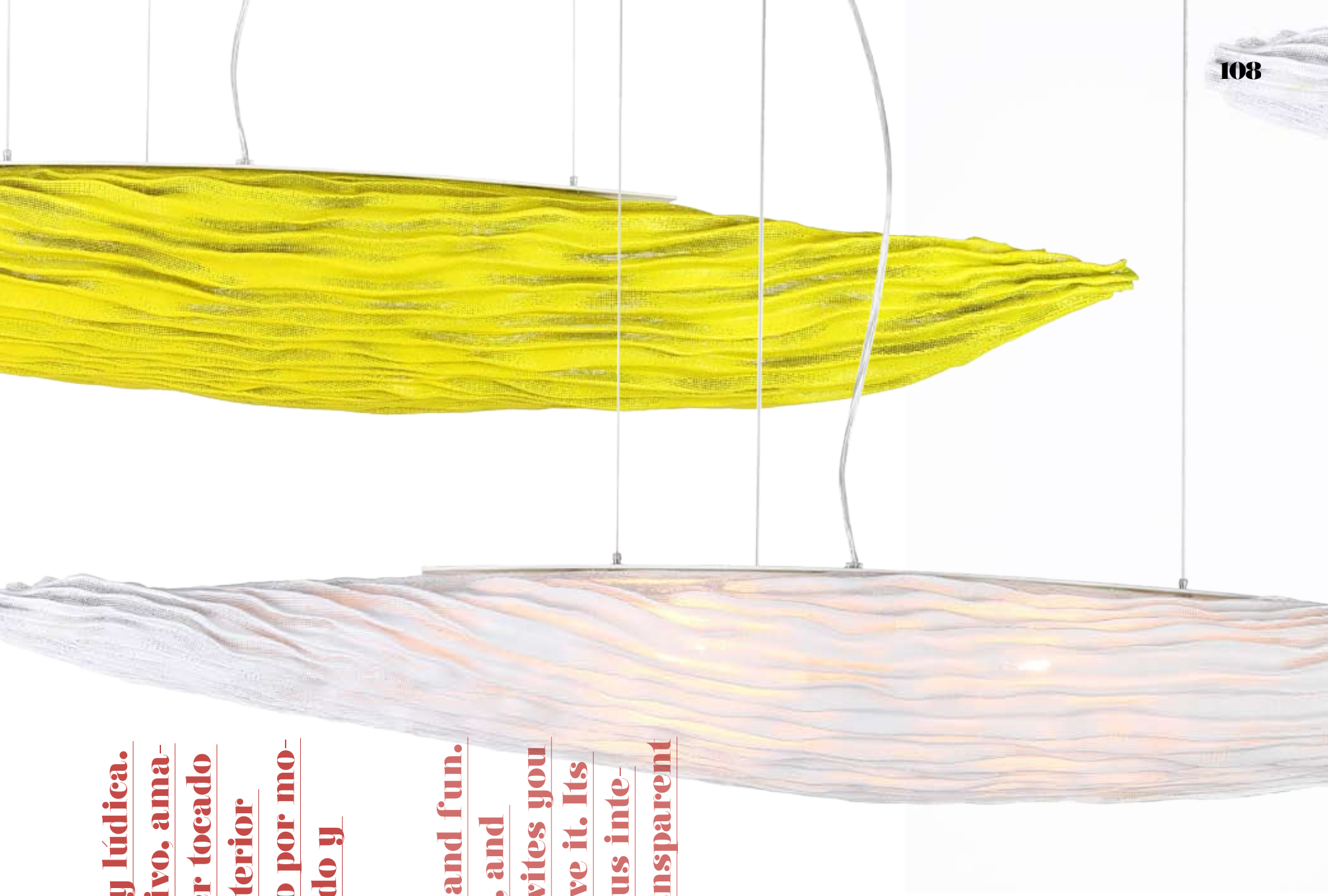

109

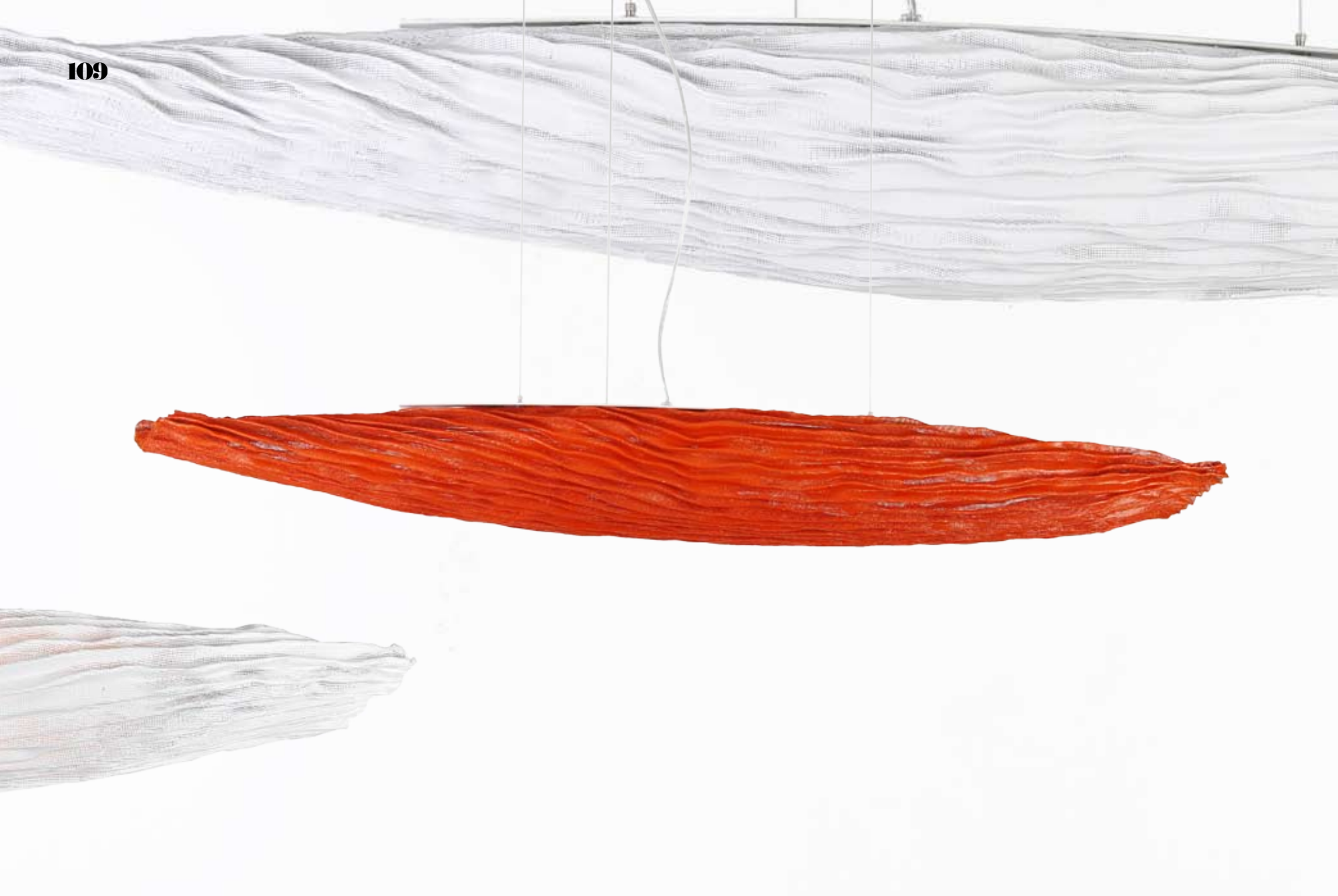

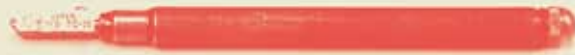

Production/1

Son las siete y media de la mañana, comenzamos la jornada. Las manos se estiran y despiertan al contacto con los materiales que esperan a que se les de vida, forma, alma.

It is 7:30 AM, we start our working day. We stretch our hands and start to get in touch with the materials, waiting to be brought into the world, with their unique shape and soul.

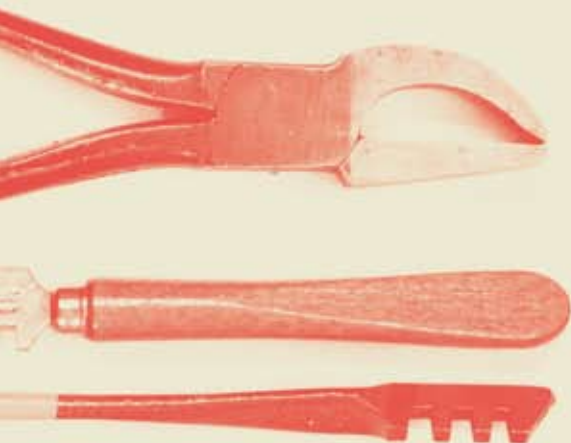

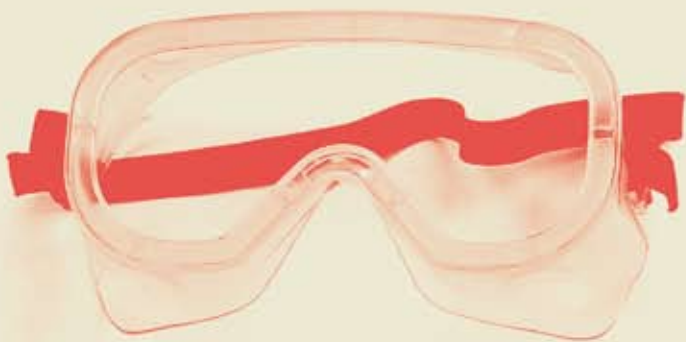
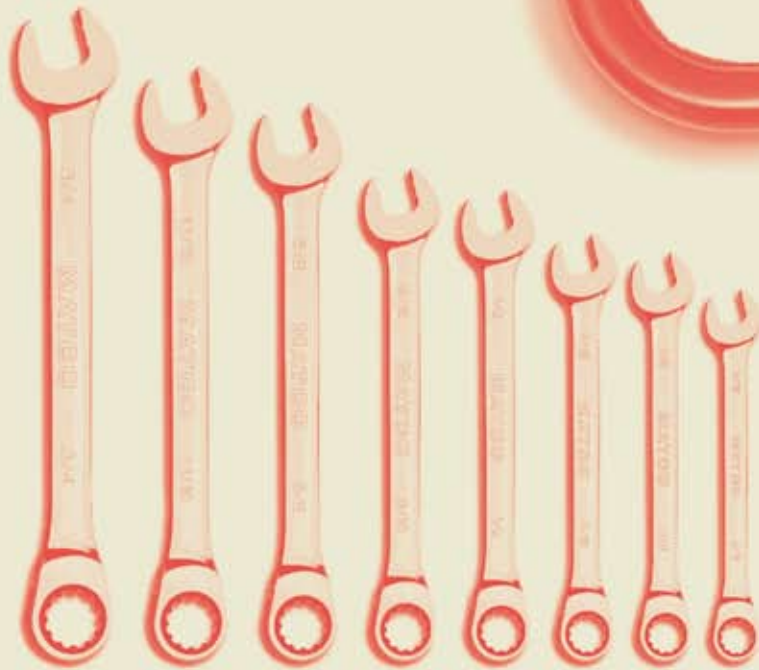
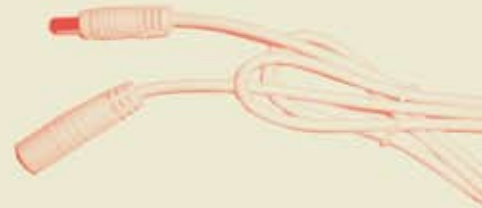

La lámpara Norr surge de sus raíces escandinavas y de los materiales que permanentemente se emplean allí. Lana y madera crean un entorno cálido y acogedor además de invitarte a tocar y a sentir los materiales.

Norr lamp takes its starting point from her Scandinavian roots and the materials often used there. The wool and wood create a warm and cozy atmosphere as well as they invite you to touch it and feel the materials.



Noir

DESIGNED BY
Christina Liljenberg



holá!
somos La m

Apu
La m
es la de

Miuru



Mi03 Lámpara de Pie *Floor Lamp*
Ø 40 x 13 cm 15^{3/4} x 5^{1/4} in ↓ 215 cm 84^{3/4} in ↔ 235 cm 92^{3/4} in

**Tejidos que envuelven
cuerpos, tejidos que
envuelven luz, que tie-
nen capacidad de
resaltar colores, que
se combinan de dis-
tintas formas. Un vo-
lumen bello y una
textura fresca y agra-
dable que recuerda
pétalos de flores
suggerentes.**



Mi06

Aplique / Plafón *Wall / Ceiling Lamp*
↔60 cm 23^{3/4} ↑50 cm 19^{3/4} ↙14 cm 5^{3/4} in

Fabrics that wrap bodies,
fabrics that wrap light, ready
to highlight colours, joint
together in different forms.
A beautiful volume and a
pleasant and fresh texture
that reminds of petals of
suggestive flowers.





Mi04G Colgante *Pendant Lamp*
Ø53x16 cm 21x6^{1/2} in †150 cm 96 in

Mi04 Colgante *Pendant Lamp*
Ø40x13 cm 15^{3/4}x5^{1/4} in †150 cm 96 in



Una hoja de metal redistribuida en el espacio como un elemento móvil está inspirada en una estructura rizomática. El elemento base forma una suspensión en cascada partiendo de un punto central que a continuación se ramifica para difractar la luz de una forma sutil.

A metal plate distributed in the space like a mobile element. It is inspired by a rhizomatic structure. The base element forms a suspension waterfall shaped by starting from a central spot branched out in order to diffract the light in a subtle manner.

Rhi—
zome

DESIGNED BY
Matali Crasset

Bety

DESIGNED BY
Arturo Álvarez



Fetichismo, sofisticación, la femineidad recreada, una forma inacabada, libre. Un objeto con historia, con memoria, que aporta una nueva narrativa.

Fetishism, sophistication, recreated femininity, an unfinished shape, free. An object with history and memory, which contributes to a new narrative.



Be03 Lámpara de Pie Floor lamp
Ø 65 x 55 cm 25^{3/4} x 21^{3/4} in 1185 cm 73 in



Be04-1 Colgante *Pendant Lamp*
 ∅ 35 cm 14 in ↓ 30 cm 12 in ↑ 150 cm 96 in

Be04 Colgante *Pendant Lamp*
 ∅ 65 x 55 cm 25^{3/4} x 21^{3/4} in ↓ 150 cm 96 in

Tiras de polipropileno se trabajan de distintas maneras para lograr formas con volumen y gracia aportando unos diseños muy frescos y ligeros que tamizan la luz de forma cálida.

Strips of polypropylene moulded in different ways to obtain large forms with volume and grace. Very fresh and light designs which filter the light in a warm way.



Be01

Sobremesa Table Lamp
 Ø 35 x 35 cm 14 x 14 in 167 cm 26 1/2 in



DESIGNED BY
Héctor Serrano

Woods



Inspirada en la magia de un bosque, la luz se deja ver entre sus majestuosos árboles. Su caos controlado y el juego de luz y sombra le concede naturalidad, carácter y una agradable luz directa donde se requiere.

Inspired by the magic of a forest, the light escapes through its majestic trees. The controlled chaos and the game played by light and shadow gives naturalness, character and a pleasant direct light wherever required.

It adapts to large areas.
A product in birch grown
in responsibly managed
forests, limited but safe
enough packaging and an
energy saving lighting
source complete this con-
cept of sustainability.



Se adapta a grandes espa-
cios. Un producto sostenible
al utilizar abedul proce-
dente de bosques controla-
dos, un embalaje reducido
y una fuente de luz de bajo
consumo completan este
concepto de sostenibilidad.





Production/2

Personas que se conocen muy bien y trabajan de forma coordinada. Sus herramientas son los instrumentos con los que crear una sinfonía de lámparas hechas con emoción.

Well-known colleagues that jointly work together. Their tools are the musical instruments with which they create a symphony of lamps made with emotions.



Uvi



La belleza y calor de la madera surge a través de una forma sinuosa, formada por una sucesión de barritas de tablero marino, por las que se escurre la luz de forma sutil.

The beauty and warmth of the wood emerges between a sinuous shape, created by a succession of bars in plywood. The light slips away in a subtle form in between them.

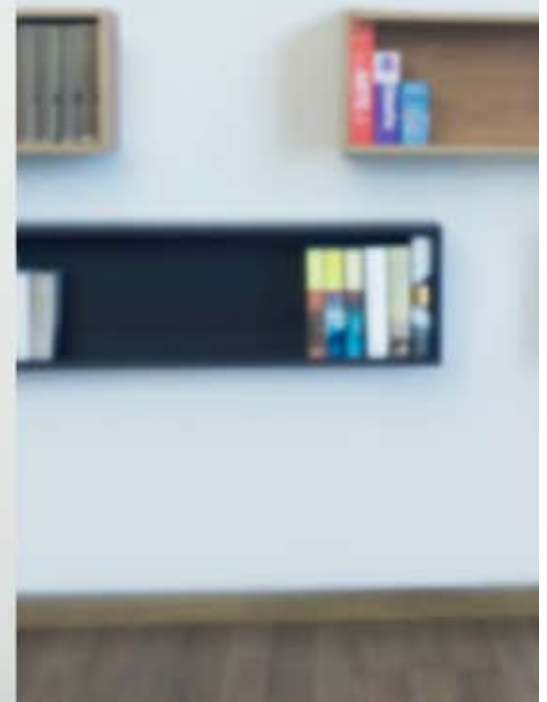

Ux04 Colgante *Pendant Lamp*
↔98 cm 38^{3/4} in †13 cm 5^{1/4} in †23 cm 9^{1/4} in †150 cm 96 in

Ux06 Aplique *Wall Lamp*
↔64 cm 25^{1/4} in †13 cm 5^{1/4} in †10,5 cm 4^{1/4} in

La geometría se combina con la luz y una infinidad de composiciones posibles surgen para cubrir techos o paredes que recuerdan el orden y repetición armónica del universo y la naturaleza.

The geometry, mixed with the light and an infinity of possible combinations, arises to cover ceilings or walls, remembering the order and harmonic repetition of the universe and nature.



Hexa





Fluo

DESIGNED BY
Arturo Álvarez

Ver o no ver, estar de forma sutil y mágica. Transparencias y volúmenes danzan juntos entrelazándose en un abrazo único e infinito. Un dejarse llevar, intuir y soñar.

To see or not to see, to be in a gentle and magical form. Transparency and volume dancing together intertwining in a unique and endless hug. Floating, sensing and dreaming.

FL04 Lámpara Colgante *Pendant Lamp*
↑60 cm 23^{3/4} in ↔80 cm 31^{1/2} in ↑200 cm 96 in



2009



Curvas



Una irregularidad continua, piezas curvas que encajan unas con otras, un movimiento sutil, una sensación de bienestar.

Una colección cálida y elegante.

A continuous irregularity, curved pieces that fit into each other in a subtle movement, a sensation of well-being.

A warm and elegant collection.

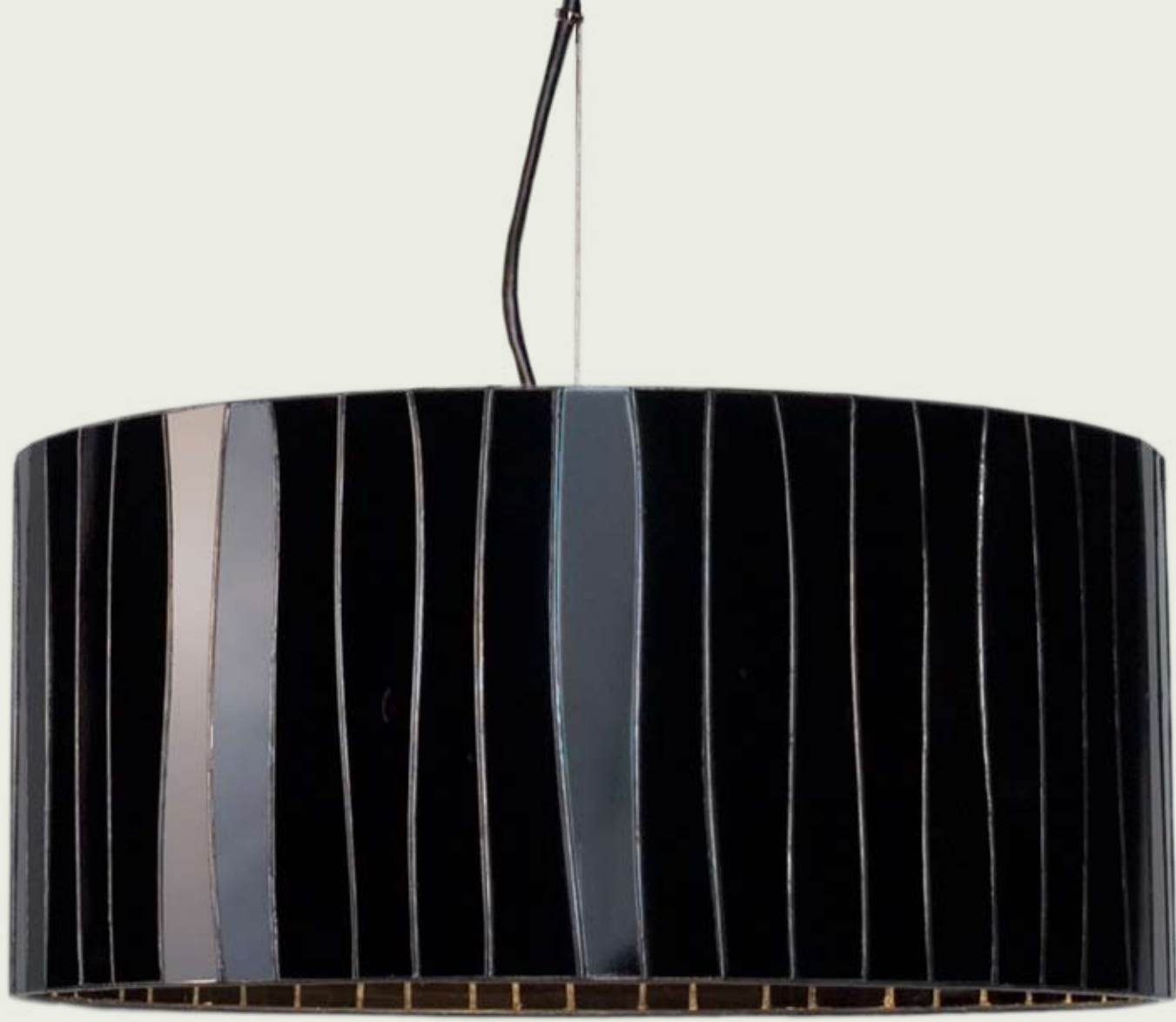

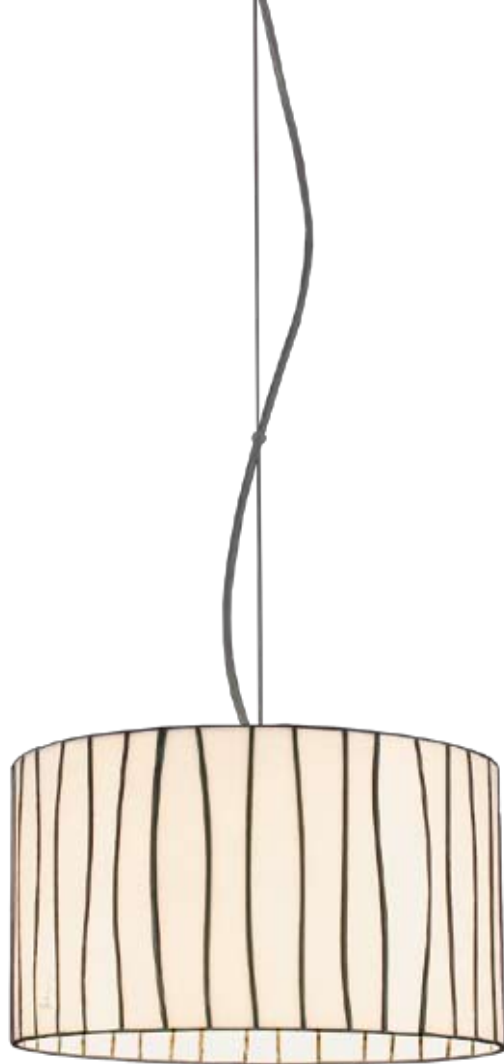

Cv04-1 Suspensión *Pendant Lamp*
Ø15 x 11,5 cm 6 x 4^{3/4} in
↓ 150 cm 96 in

Cv04 Suspensión *Pendant Lamp*
Ø32 x 18 cm 12^{3/4} x 7^{1/4} in
↓ 150 cm 96 in

Cv04G Suspensión *Pendant Lamp*
Ø50 x 23 cm 19^{3/4} x 9^{1/4} in
↓ 150 cm 96 in



Aros

DESIGNED BY
Arturo Álvarez

Tiras de polipropileno se trabajan de distintas maneras para lograr formas con volumen y gracia aportando unos diseños muy frescos y ligeros que tamizan la luz de forma cálida.

Strips of polypropylene moulded in different ways to obtain large forms with volume and graceful. Very fresh and light designs which filter the light in a warm way.

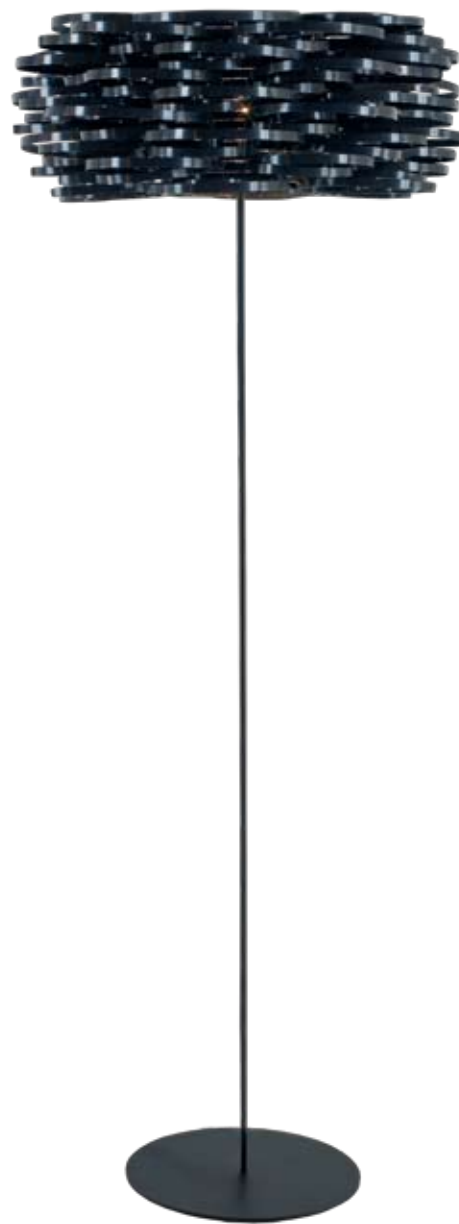
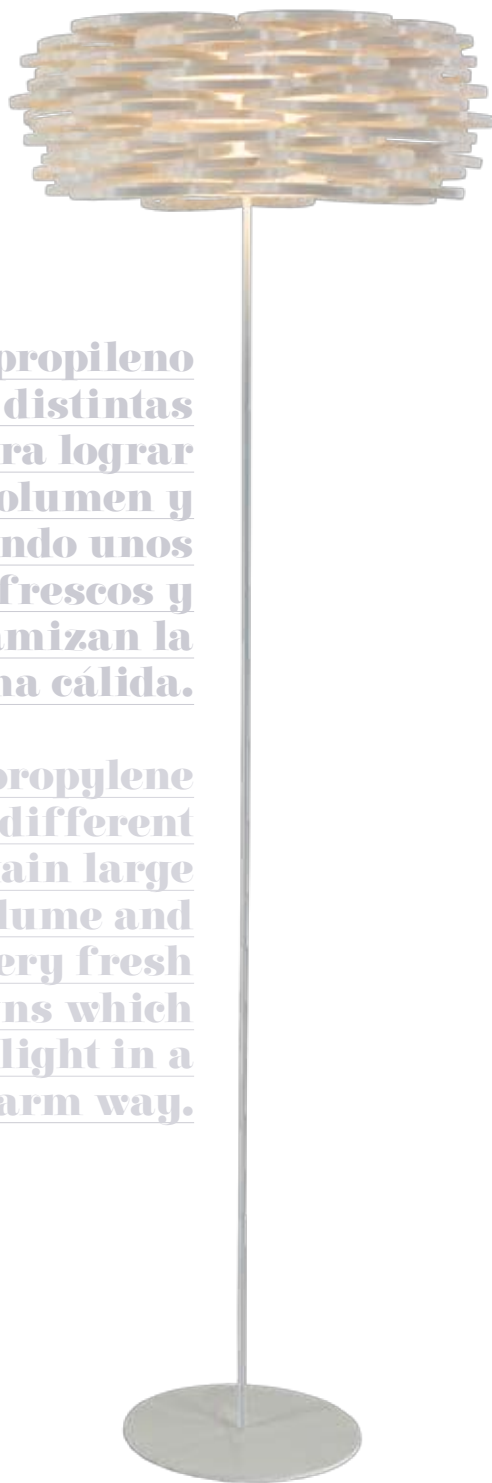



**Los cuerpos celestes
girando una y otra vez,
y nosotros con ellos,
en una danza sin fin,
sin tiempo. Llena de
armonía. La luz, capri-
chosa, se escapa por
los espacios abiertos.**

**The heavenly bodies
spinning around, time
and again so we with
them, in an endless
dance, timeless, full
of harmony. The light,
fussy, escapes bet-
ween the open spaces.**

Holes

DESIGNED BY
Bertjan Pot



Inspirada en las cometas y las matemáticas es una luminaria hecha con 20 triángulos, 30 barras, 12 conectores y 57 pequeños agujeros. Un poliedro del que escapan muchos haces de luz que le dan vida y frescura.

Inspired by kites and maths it is a light made out of 20 triangles, 30 bars, 12 connectors and 57 small holes. Lots of beams of light escaping from a polyhedron and giving it life and freshness.

Holes está hecha en Tyvek® un tejido no tejido, un material tecnológico, hecho a partir de fibras de polietileno, ligero, impermeable, alta resistencia a los desgarros y totalmente reciclable

Holes is made with Tyvek® a non woven and technological material made from polyethylene fibers, lightweight, waterproof, with high tear resistance and completely recyclable.

No01
Lámpara de Mesa *Table Lamp*
↔ 27 cm 10^{3/4} in 135 cm 14 in



Norman



No06 Aplique Wall Lamp
 ↕ 119cm 47in ↕ 6.5cm 2.3/4in ↗ 9.5cm 3.3/4in



No06P Aplique Wall Lamp
 ↕ 30cm 12in ↕ 6.5cm 2.3/4in ↗ 9.5cm 3.3/4in

Una colección actual de líneas contemporáneas, elegante y funcional. Un diseño atemporal de formas rectas que aporta soluciones para entornos íntimos y también para espacios públicos.

A collection for today, with contemporary lines that are elegant and practical. A timeless design with straight lines that provides with solutions for intimate environments and public spaces.

155

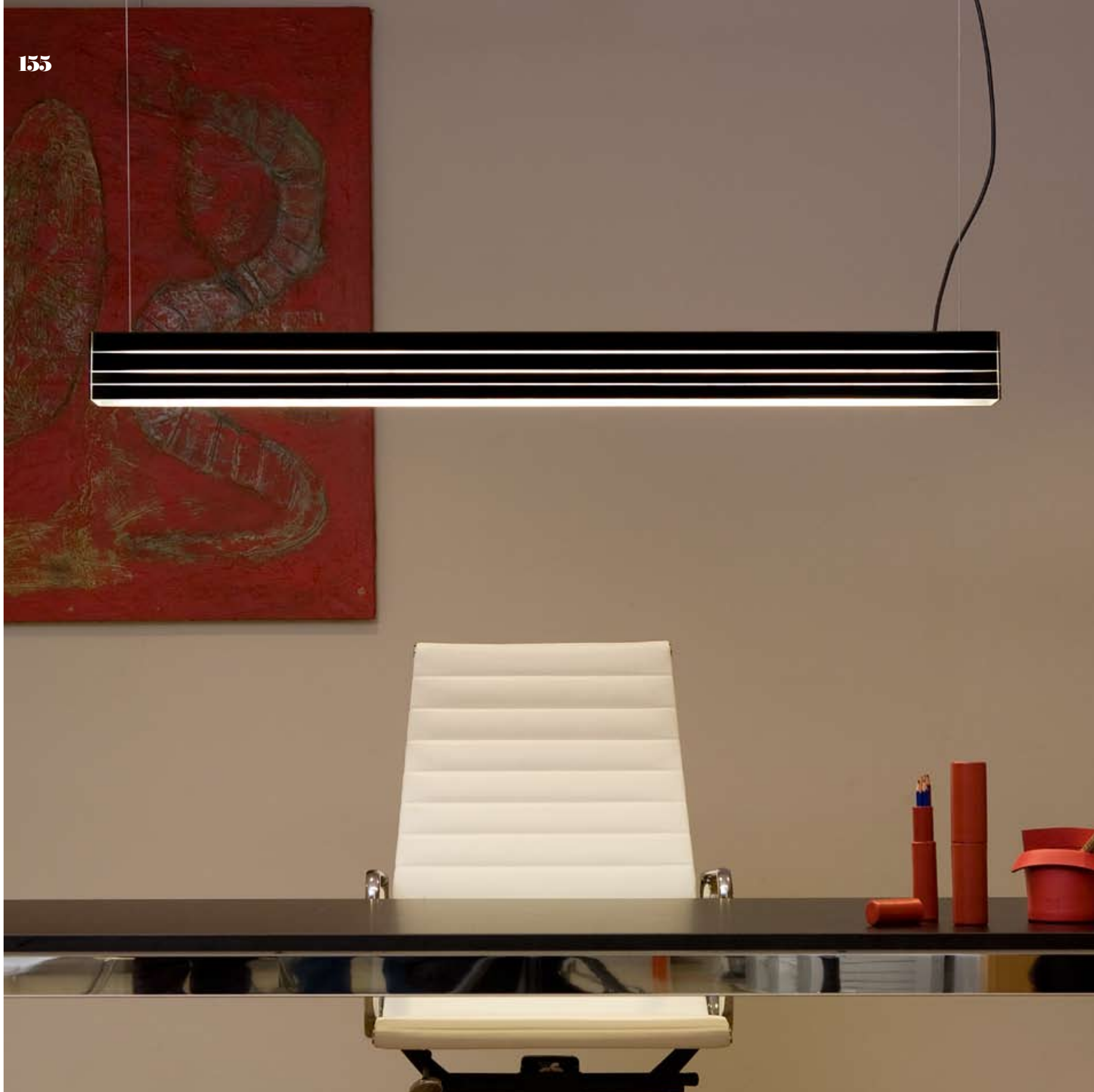

No04 Colgante *Pendant Lamp*
↔119 cm 47 in ↓9,5 cm 3^{3/4} in ↗6,5 cm 2^{3/4} in ↑150 cm 96 in



Luna

DESIGNED BY
Martín de Azúa

**La luna en la tierra.
Podemos tocarla, abra-
zarla, jugar con ella y
transportarla. Atrapar
a través de los senti-
dos parte de su encan-
to y misterio.**

**The moon on the Ear-
th. We can touch it,
embrace it, play with
it and transport it.
We can grasp with
our senses part of its
charm and mystery.**



La técnica utilizada es el moldeo rotacional una innovación tecnológica a la que se ha buscado dotar de alma, funcionalidad y belleza. De tacto suave se vuelve cercana y llena de emoción.

The technique used is the slush moulding, an innovative technology which has been provided with soul, versatility and beauty. With a gentle touch, it turns closer and full of emotion.



Nace LAB Arturo alvarez, un laboratorio de ideas abierto a los diseñadores. En el año 2008, empujados por nuestra inquietud y constante búsqueda de la innovación, creamos LAB arturo alvarez, un marco nuevo, un laboratorio de ideas para dar cabida a la sensibilidad de otros diseñadores y también del propio Arturo Álvarez, conjugando el ingenio, la innovación y la experimentación técnica y formal con el estilo propio de nuestra empresa.

LAB arturo alvarez is created, a laboratory of ideas open to designers. In 2008, driven by our own motivation and constant search for innovation, we created LAB arturo alvarez, a new setting, a laboratory of ideas to make room for the sensibilities of other designers in addition to Arturo Álvarez himself. Combining ingenuity, innovation and technical and formal experimentation with the style of our company.

Arturo Álvarez



Es uno de los fundadores y motor creativo de la empresa que lleva su nombre. A lo largo de su carrera ha sido capaz de conectar con cientos de personas. El modelo Bety está en el Museo de las Artes Decorativas de Barcelona. Le conceden el prestigioso premio GOOD DESIGN en 2008 por el diseño Gea y en 2009 por Fluo.

He is one of the founders and the core engine of the company bearing his name. Along his career he has been able to bring together hundreds of persons. His Bety lamp is shown at the Museum of Decorative Arts in Barcelona. In 2008 he won the prestigious "Good Design" award with the design Gea and, in 2009, with Fluo.

El Último Grito



Rosario Hurtado y Roberto Feo. Experimentales, rebeldes y vanguardistas pero también sensibles y cercanos. Esto es palpable tanto en sus productos como en las instalaciones y exposiciones que hacen alrededor del mundo. Han ganado, entre otros, el "Red Dot Award" 2006 y 2010 en Lighting Design

Rosario Hurtado and Roberto Feo. Experimental, vanguardist and rebels but also sensitive and nearby. This is evident in their products and facilities as making presentations around the world. They gained, among others, the Red Dot Award in 2006 and 2010 Lighting Design.

Martín Azúa



Pura sensibilidad y creatividad. Convierte a cada uno de sus diseños en una pieza especial y única. Cuenta con una amplia participación en espacios, proyectos y exposiciones. Piezas suyas están en el MOMA de NY y en el "Vitra Design Museum". Ganó el "Delta de Plata 2007".

Pure sensitivity and creativity. Converts in a special and unique piece each of his designs. Counts with an extensive participation in spaces, projects and exhibitions. His pieces are in the MOMA of NY and in the "Vitra Design Museum". He won the "Delta de Plata 2007" ("Silver Delta Award").

Matali Crasset



Polifacética, se reinventa cada vez, trabaja diseñando cosas muy pequeñas, muy grandes, realizando proyectos, creando espacios o publicaciones. Ha trabajado con gente tan diversa como Denis Santachiara o Philippe Starck. Ha expuesto entre otros en el Victoria et Albert Museum.

Versatile, she reinvents herself every time she works by designing little things, big things, carrying out projects, creating spaces or publications. She worked with such diverse people as Denis Santachiara or Philippe Starck. Among other exhibitions, she has exhibited at the Victoria & Albert Museum.

Bertjam Pot



“Me fascinan los procesos de producción y las materias primas. Todo se hace partiendo de unas materiales. Casi todos los diseños surgen de la experimentación con materiales, nuevos y antiguos. Sentir un producto es tan importante como su apariencia”.

“My main fascination are materials and production processes. Everything is made out of raw materials. Almost all designs come from experimenting with materials, old and new. The way a product feels is just as important as the way it looks.”

Hector Serrano

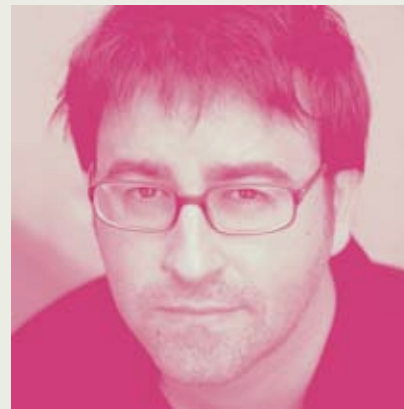

Sus diseños rebozan frescura e innovación. Ha recibido varios premios como el “Premio nacional de Diseño. No aburridos” o el “Peugeot Design”. Sus creaciones pueden verse en el V&A de Londres o en el Central Museum of Amsterdam entre otros. Realiza eventos e instalaciones singulares a lo largo del mundo.

His designs spread freshness and innovation. He received several awards such as “Spanish Design Award. Not bored” or “Peugeot Design”. His creations can be admired at the V&A in London or at the Central Museum of Amsterdam. He organizes events and exceptional installations all over the world.

Christina Liljenberg



Christina Liljenberg trabaja en su estudio de Copenhague. Gran parte de su trabajo lo ha desarrollado en el sector del mueble. Participará en la exposición “Mindcraft”, que incluye productos de los mejores diseñadores daneses del momento. Ha sido premiada por la Fundación de Arte Danés.

Christina Liljenberg works from her Copenhagen based studio, mostly with furniture. She will take part of the exhibition “Mindcraft” which is showcasing products from the best current Danish designers. Her work has been awarded by the Danish Arts Foundation.

Proyectos de iluminación a medida

Tailor-made lighting projects

We customize and adapt all the designs of our catalogue and develop special models to offer a personal touch, different and unique to every project.

Personalizamos y adaptamos los diseños de catálogo y realizamos modelos especiales para ofrecer un toque personal, diferenciado y único a cada uno de los proyectos.



Cultural space: Ciudad de la Cultura
Place: Santiago de Compostela
Architect: Peter Eisenman
Project: ON/OFF
Designer: Martín Azúa
Lighting manufacturer: arturo alvarez

Lamps made in an exclusive proprietary material developed by Arturo Álvarez in mesh and silicone.

Lámparas hechas en el material exclusivo desarrollado por Arturo Álvarez de malla con silicona.

Directorio técnico

Technical directory

vidrio
glass



01
NEGRO
BLACK



02
BLANCO
WHITE



77
NARANJA
PALE ORANGE



83
AZUL FUERTE
DARK BLUE



84
ROSA CLARO
LIGHT PINK



85
VERDE PISTACHO
PISTACHIO GREEN



87
ARENA
SAND



89
AMBAR OSCURO
DARK AMBER

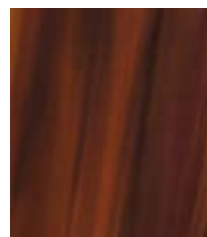

90
MARRÓN
BROWN



92
VERDE LIMA
LIME GREEN



95
BEIGE
BEIGE



102
ROJO
RED

lana
wool

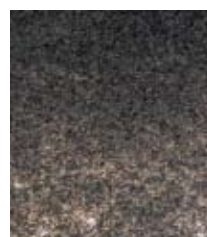

30
GRIS OSCURO
DARK GREY



31
GRIS CLARO
LIGHT GREY



32
AZUL
BLUE



33
VERDE
GREEN

tela
fabric



20
NEGRO
BLACK



21
BLANCO
WHITE



22
GRIS
GREY

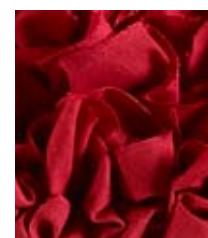

23
ROJO
RED



24
GRANATE
DEEP RED



25
VERDE
GREEN

COMBINACIONES DE COLORES
COLOUR COMBINATIONS

TULIPA | LAMPSHADE

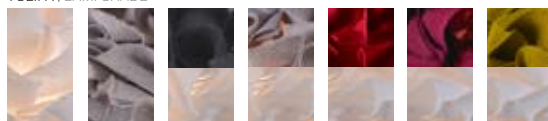

SOPORTE | SUPPORT

LÁMPARA DE PIE: Metal Blanco y Cable Transparente.

FLOOR LAMP: White Metal and Transparent Cable.

LÁMPARA COLGANTE: Metal Blanco y Cable Transparente.

PENDANT: White Metal and Transparent Cable.

NOTA: En las combinaciones de dos colores, el color que se sitúa en la parte superior será siempre el tono más oscuro.

TULIPA | LAMPSHADE

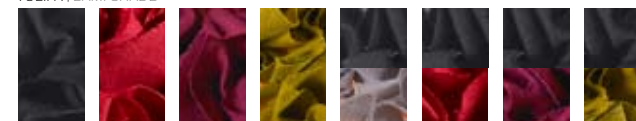

SOPORTE | SUPPORT

LÁMPARA DE PIE: Metal Negro y Cable Negro.

FLOOR LAMP: Black Metal and Black Cable.

LÁMPARA COLGANTE: Metal Negro y Cable Transparente.

PENDANT: Black Metal and Transparent Cable.

NOTE: For combinations of two colours, the colour at the top will always be the darker one.



BL
BLANCO
WHITE



WE
WENGUÉ
WENGE



AM
AMARILLO
YELLOW

tablero marino
plywood



AISI 304
ACERO INOXIDABLE
STAINLESS STEEL

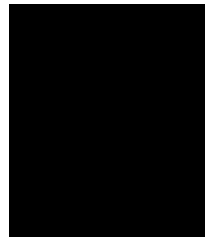

NEGRO
METAL PINTADO NEGRO
BLACK PAINTED METAL

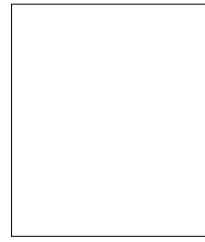

BLANCO
METAL PINTADO BLANCO
WHITE PAINTED METAL

metal
metal



B
BLANCO
WHITE



NA
NARANJA
ORANGE



N
NEGRO
BLACK

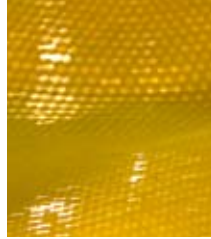

A
AMARILLO
YELLOW



G
GRIS
GREY

silicona
silicone



40
GRANATE
DEEP RED



41
BEIGE
BEIGE



42
BLANCO
WHITE



43
GRIS CLARO
LIGHT GREY

celulosa prensada
pressed cellulose



44
VERDE CLARO
LIGHT GREEN



45
AZUL CLARO
LIGHT BLUE



46
ROJO
RED



47
MARRÓN
BROWN

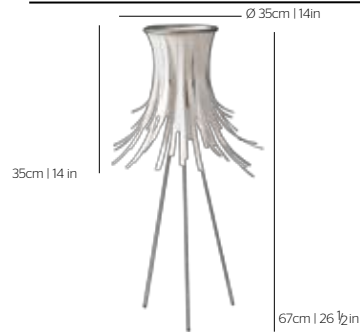

bety

by Arturo Álvarez

BE01
POLIPROPILENO | POLYPROPYLENE
Un color | One colour



METAL



CABLE
Negro o transparente
Black or transparent

230V - 50Hz

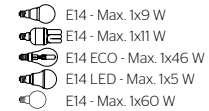

120V - 60Hz

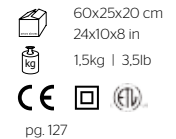

pg. 127



curvas

by Arturo Álvarez

CV01
VIDRIO | GLASS
Un color | One colour



METAL



CABLE
Negro o transparente Black
or transparent

230V - 50Hz

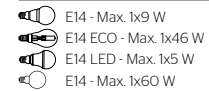

120V - 60Hz

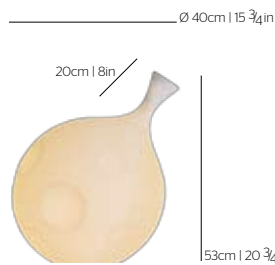
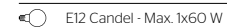

lua

by Martín Azúa

LU01
POLIETILENO | POLYETHYLENE



CABLE
Negro. Largo 4m.
Black. Length 4m.

2230V - 50Hz (IP55, in&out EU* only)

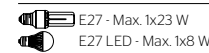

120V - 60Hz (IP20, indoor use only)

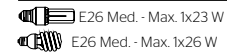

* European Union



pg. 158, 159



muu

by Arturo Álvarez

MU01
SILICONA | SILICONE
Un color | One colour



METAL



CABLE
Negro o transparente
Black or transparent

230V - 50Hz

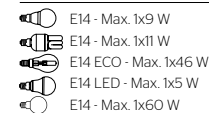

120V - 60Hz

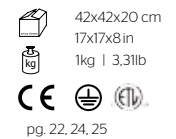

pg. 22, 24, 25



muu

by Arturo Álvarez

MU02
SILICONA | SILICONE
Un color | One colour



METAL



CABLE
Negro o transparente
Black or transparent

230V - 50Hz

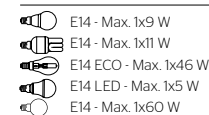

120V - 60Hz



pg. 22, 24, 25

nevo by Arturo Álvarez



NEO1

SILICONA | SILICONE

Un color | One colour



> Nota: Las dimensiones de la tulipa indicadas son solo aproximadas y nunca exactas.

Note: The indicated shade dimensions are only approximate, never exact.

METAL



CABLE

Negro o transparente
Black or transparent

230V - 50Hz

- E14 - Max. 2x9 W
- E14 - Max. 2x11 W
- E14 ECO - Max. 2x46 W
- E14 LED - Max. 2x5 W
- E14 - Max. 2x60 W

120V - 60Hz

- E12 Candel - Max. 2x60 W



pg. 32

nevo by Arturo Álvarez

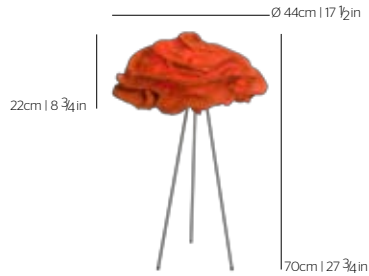

NEO2

SILICONA | SILICONE

Un color | One colour



> Nota: Las dimensiones de la tulipa indicadas son solo aproximadas y nunca exactas.

Note: The indicated shade dimensions are only approximate, never exact.

METAL



CABLE

Negro o transparente
Black or transparent

230V - 50Hz

- E14 - Max. 2x9 W
- E14 - Max. 2x11 W
- E14 ECO - Max. 2x46 W
- E14 LED - Max. 2x5 W
- E14 - Max. 2x60 W

120V - 60Hz

- E12 Candel - Max. 2x60 W



pg. 31

norman by Arturo Álvarez



NOO1

VIDRIO | GLASS

Un color | One colour



Un color | One colour

METAL



CABLE

Negro o transparente
Black or transparent

230V - 50Hz

- G24d2 - Max. 1x18 W

120V - 60Hz

- GX24q-2 4-pin - 1x18 W

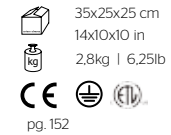

pg. 152

shio by Arturo Álvarez



SH02

SH02-D con regulador | with dimmer

TABLERO MARINO | PLYWOOD

Un color | One colour



CABLE

Negro o transparente
Black or transparent

> Difusor superior e inferior
Top and bottom diffuser

230V - 50Hz

- 2GX13 - Max. 1x22 W

120V - 60Hz

- 2GX13 - Max. 1x22 W



pg. 97

tati by Arturo Álvarez



TAO2

SILICONA | SILICONE

Un color | One colour



> Nota: Las dimensiones de la tulipa indicadas son solo aproximadas y nunca exactas.

Note: The indicated shade dimensions are only approximate, never exact.

METAL



CABLE

Negro o transparente
Black or transparent

230V - 50Hz

- E14 - Max. 2x9 W
- E14 - Max. 2x11 W
- E14 ECO - Max. 2x46 W
- E14 LED - Max. 2x5 W
- E14 - Max. 2x60 W

120V - 60Hz

- E12 Candel - Max. 2x60 W



pg. 60

vento

by Arturo Álvarez



VNO1

OPCIONES DE VIDRIO | GLASS OPTIONS
Un color | One colour

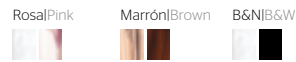

CABLE
Negro o transparente
Black or transparent

> Incluye Difusor
Diffuser included

230V - 50Hz

- GU9 - Max. 2x9 W
- G9 ECO - Max. 2x42 W (Philips)
- G9 ECO - Max. 2x33 W (Osram)

120V - 60Hz

- Ultra Squat Mini Spiral GU24 - 2x13W
- G9 Bi-pin - Max. 2x40 W



pg. 86

vento

by Arturo Álvarez



VNO2

OPCIONES DE VIDRIO | GLASS OPTIONS
Un color | One colour

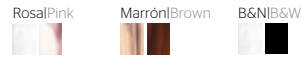

CABLE
Negro o transparente
Black or transparent

> Incluye Difusor
Diffuser included

230V - 50Hz

- GU9 - Max. 4x9 W
- G9 ECO - Max. 4x42 W (Philips)
- G9 ECO - Max. 4x33 W (Osram)

120V - 60Hz

- Ultra Squat Mini Spiral GU24 - 4x13W
- G9 Bi-pin - Max. 4x40 W



ventopop

by Arturo Álvarez



VNO1POP

Opciones de vidrio | GLASS OPTIONS
Combinación POP | POP combination



CABLE
Negro o transparente
Black or transparent

> Incluye Difusor
Diffuser included

230V - 50Hz

- GU9 - Max. 2x9 W
- G9 ECO - Max. 2x42 W (Philips)
- G9 ECO - Max. 2x33 W (Osram)

120V - 60Hz

- Ultra Squat Mini Spiral GU24 - 2x13W
- G9 Bi-pin - Max. 2x40 W



ventopop

by Arturo Álvarez

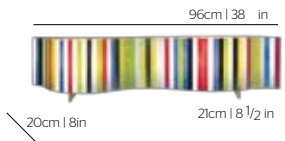

VNO2POP

OPCIONES DE VIDRIO | GLASS OPTIONS
Combinación POP | POP combination



CABLE
Negro o transparente
Black or transparent

> Incluye Difusor
Diffuser included

230V - 50Hz

- GU9 - Max. 4x9 W
- G9 ECO - Max. 4x42 W (Philips)
- G9 ECO - Max. 4x33 W (Osram)

120V - 60Hz

- Ultra Squat Mini Spiral GU24 - 4x13W
- G9 Bi-pin - Max. 4x40 W



pg. 87

aros

by Arturo Álvarez

Ø 60cm | 23 3/4 in



23cm | 9 in

160cm | 63 in

AR03

POLIPROPILENO
POLYPROPYLENE

Un color | One colour



METAL



CABLE

Negro o transparente | Black or transparent

> Incluye difusor
Diffuser included
230V - 50Hz

E27 - Max. 1x23 W

E27 - Max. 1x23 W

E27 LED - Max. 1x14 W

E27 ECO - Max. 1x77 W

E27 LED - Max. 1x8 W

E27 - Max. 1x100 W

120V - 60Hz

E26 Med. - Max. 1x100 W

E26 Med. - Max. 1x26 W

170x10x10cm | 32x61x61cm
67x4x4in | 13x24x24in

4kg | 8.8lb pg. 121

aros

by Arturo Álvarez

Ø 60cm | 23 3/4 in



23cm | 9 in

188cm | 74 in

AR03G

POLIPROPILENO
POLYPROPYLENE

Un color | One colour



METAL



CABLE

Negro o transparente | Black or transparent

> Incluye difusor
Diffuser included
230V - 50Hz

E27 - Max. 1x23 W

E27 - Max. 1x23 W

E27 LED - Max. 1x14 W

E27 ECO - Max. 1x77 W

E27 LED - Max. 1x8 W

E27 - Max. 1x100 W

120V - 60Hz

E26 Med. - Max. 1x100 W

E26 Med. - Max. 1x26 W

180x10x10cm | 32x61x61cm
71x4x4in | 13x24x24in

4kg | 8.8lb pg. 121

bety

by Arturo Álvarez

Ø 65cm | 25 3/4 in



55cm | 21 3/4 in

185cm | 73 in

BE03

POLIPROPILENO
POLYPROPYLENE

Un color | One colour



METAL



CABLE

Negro o transparente | Black or transparent

230V - 50Hz

E27 - Max. 1x23 W

E27 - Max. 1x23 W

E27 LED - Max. 1x14 W

E27 ECO - Max. 1x77 W

E27 LED - Max. 1x8 W

E27 - Max. 1x100 W

120V - 60Hz

E26 Med. - Max. 1x100 W

E26 Med. - Max. 1x26 W

180x10x10cm | 43x43x60cm
71x4x4in | 17x17x24in

6.5kg | 14.3lb pg. 133, 134, 135

curvas

by Arturo Álvarez

Ø 50cm | 19 3/4 in



23cm | 9 1/4 in

165cm | 65 in

CV03G

VIDRIO | GLASS

Un color | One colour



METAL



CABLE

Negro o transparente | Black or transparent

> Incluye regulador y difusor
Dimmer and diffuser included
230V - 50Hz

E27 - Max. 4x23 W

E27 Dimmer - Max. 4x18 W

E27 ECO - Max. 4x77 W

E27 LED - Max. 4x8 W

E27 - Max. 4x100 W

120V - 60Hz

E26 Med. - Max. 4x100 W

E26 Med. - Max. 1x26 W

185x45x25cm | 60x60x30cm
73x18x10in | 24x24x12in

15kg | 33lb

gea

by Arturo Álvarez

28cm | 11 1/4 in



180cm | 71 in

GE03

SILICONA | SILICONE

Un color | One colour



CABLE

Negro o transparente | Black or transparent

> Incluye difusor y regulador
Diffuser and dimmer included
230V - 50Hz

E27 - Max. 5x23 W

E27 Dimmer - Max. 5x18 W

E27 ECO - Max. 5x77 W

E27 LED - Max. 5x8 W

E27 - Max. 5x100 W

120V - 60Hz

E26 Med. - Max. 5x100 W

185x45x25cm
73x18x10in

19kg | 41.8lb

pg. 20, 21, 22
2008

le

by Arturo Álvarez

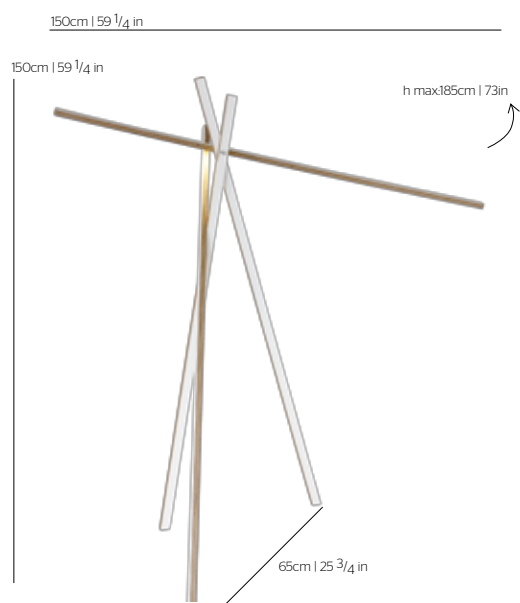

LE03

TABLERO MARINO | PLYWOOD

Un color | One colour



CABLE

Transparente

Transparent

230V - 50Hz

LED - 1x14,4 W 0,6m/A

120V - 60Hz

Not available

165x20x20cm
65x8x8in

3kg | 6.60lb

CE pg. 41, 42, 43

miuu

by Arturo Álvarez

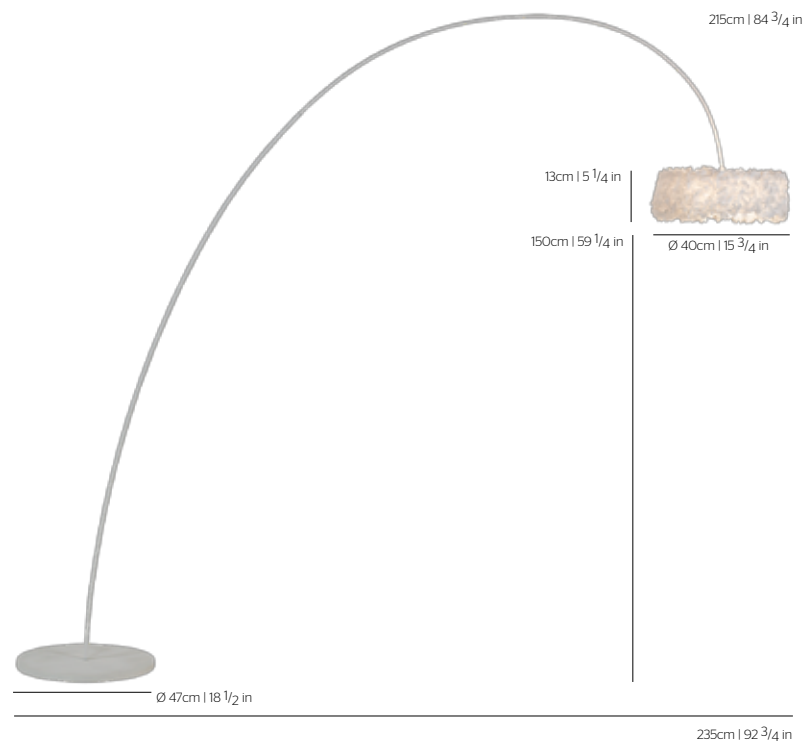

MIO3

TELA | FABRIC

Uno o dos colores | One or two colours



METAL



CABLE

Negro o transparente

Black or transparent

> Difusor superior e inferior

Top and bottom diffuser

230V - 50Hz

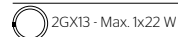

120V - 60Hz



185x45x40cm | 60x50x14cm
73x18x16in | 24x20x6in

27kg | 59.6lb

CE pg. 116

shio

by Arturo Álvarez



SH03

SH03-D con regulador | with dimmer

TABLERO MARINO

PLYWOOD

Un color | One colour



CABLE

Negro o transparente

Black or transparent

> Difusor superior e inferior

Top and bottom diffuser

230V - 50Hz

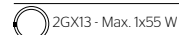

120V - 60Hz

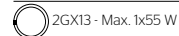

150x10x10cm | 60x60x20cm
59x4x4in | 24x24x8in

8kg | 17.6lb

CE, RoHS, ENEC, pg. 93, 94

tina

by Arturo Álvarez

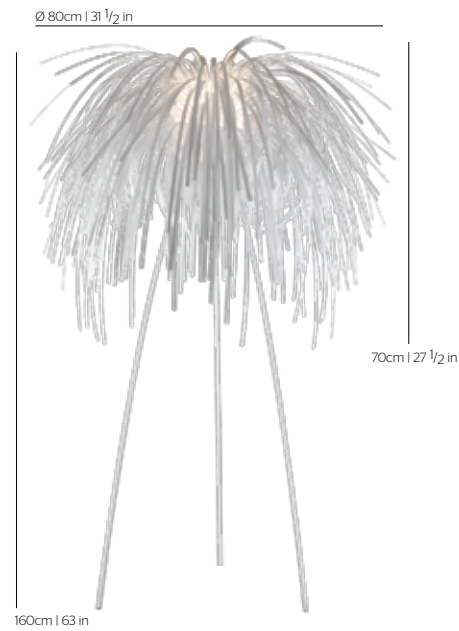

TN03

POLIPROPILENO

POLYPROPYLENE

Un color | One colour



METAL

CABLE



Negro o transparente
Black or transparent

230V - 50Hz

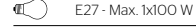
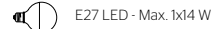
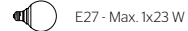

120V - 60Hz



125x31x25 cm
50x13x10 in

6,5kg | 14,3lb

CE, RoHS, ENEC, pg. 100

v

by Héctor Serrano



VV03

POLICARBONATO | POLYCARBONATE

Un color | One colour



METAL

CABLE



Negro o transparente
Black or transparent

> Incluye Difusor

Diffuser included

230V - 50Hz

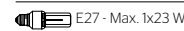

120V - 60Hz



150x50x12cm | 83x83x37cm
59x20x5in | 33x33x15in

17kg | 37.50lb

CE, RoHS, ENEC, pg. 48, 49

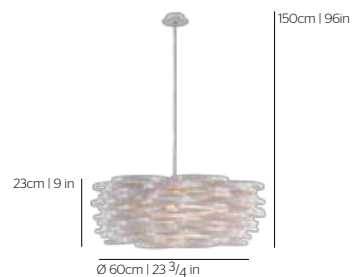

aros

by Arturo Álvarez

ARO4
POLIPROPILENO | POLYPROPYLENE
Un color | One colour



METAL



CABLE
Negro o transparente
Black or transparent

230V - 50Hz

- E27 - Max. 1x23 W
- E27 - Max. 1x23 W
- E27 LED - Max. 1x14 W
- E27 ECO - Max. 1x77 W
- E27 LED - Max. 1x8 W
- E27 - Max. 1x100 W

120V - 60Hz

- E26 Med. - Max. 1x100 W
- E26 Med. - Max. 1x18 W

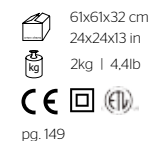

pg. 149



bety

by Arturo Álvarez

BE04
POLIPROPILENO | POLYPROPYLENE
Un color | One colour



METAL



CABLE
Negro o transparente
Black or transparent

230V - 50Hz

- E27 - Max. 1x23 W
- E27 - Max. 1x23 W
- E27 LED - Max. 1x14 W
- E27 ECO - Max. 1x77 W
- E27 LED - Max. 1x8 W
- E27 - Max. 1x100 W

120V - 60Hz

- E26 Med. - Max. 1x100 W
- E26 Med. - Max. 1x18 W

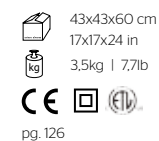

pg. 126



bety

by Arturo Álvarez

BE04-1
POLIPROPILENO | POLYPROPYLENE
Un color | One colour



METAL



CABLE
Negro o transparente
Black or transparent

230V - 50Hz

- E14 - Max. 1x9 W
- E14 - Max. 1x11 W
- E14 ECO - Max. 1x46 W
- E14 LED - Max. 1x5 W
- E14 - Max. 1x60 W

120V - 60Hz

- E12 Candel - Max. 1x60 W

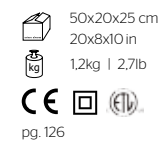

pg. 126



coral cay

by Arturo Álvarez

COCY04
SILICONA | SILICONE
Un color | One colour



METAL



CABLE
Transparente
Transparent

230V - 50Hz

- E27 - Max. 1x23 W
- E27 - Max. 1x23 W
- E27 LED - Max. 1x14 W
- E27 ECO - Max. 1x77 W
- E27 LED - Max. 1x8 W
- E27 - Max. 1x100 W

120V - 60Hz

- E26 Med. - Max. 1x100 W



pg. 15, 17, 19



coral galaxea

by Arturo Álvarez

COGA04
SILICONA | SILICONE
Un color | One colour



METAL



CABLE
Transparente
Transparent

230V - 50Hz

- E27 - Max. 1x23 W
- E27 - Max. 1x23 W
- E27 LED - Max. 1x14 W
- E27 ECO - Max. 1x77 W
- E27 LED - Max. 1x8 W
- E27 - Max. 1x100 W

120V - 60Hz

- E26 Med. - Max. 1x100 W

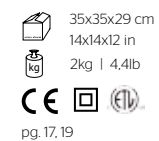

pg. 17, 19



coral reef

by Arturo Álvarez

CORE04
SILICONA | SILICONE
Un color | One colour



METAL



CABLE
Transparente
Transparent

230V - 50Hz

- E27 - Max. 1x23 W
- E27 - Max. 1x23 W
- E27 LED - Max. 1x14 W
- E27 ECO - Max. 1x77 W
- E27 LED - Max. 1x8 W
- E27 - Max. 1x100 W

120V - 60Hz

- E26 Med. - Max. 1x100 W

60x25x20 cm
24x10x8 in
 2kg | 4.4lb



pg. 17, 19



coral sea

by Arturo Álvarez

COSE04
SILICONA | SILICONE
Un color | One colour



METAL



CABLE
Transparente
Transparent

230V - 50Hz

- E27 - Max. 1x23 W
- E27 - Max. 1x23 W
- E27 LED - Max. 1x14 W
- E27 ECO - Max. 1x77 W
- E27 LED - Max. 1x8 W
- E27 - Max. 1x100 W

120V - 60Hz

- E26 Med. - Max. 1x100 W

35x35x29 cm
14x14x12 in
 2kg | 4.4lb



pg. 15, 17, 19



coral seaurchin

by Arturo Álvarez

COAU04
SILICONA | SILICONE
Un color | One colour



METAL



CABLE
Transparente
Transparent

230V - 50Hz

- E27 - Max. 1x23 W
- E27 ECO - Max. 1x77 W
- E27 LED - Max. 1x8 W
- E27 - Max. 1x100 W

120V - 60Hz

- E26 Med. - Max. 1x100 W

42x42x30 cm
17x17x12 in
 2.5kg | 5.5lb



pg. 12, 18

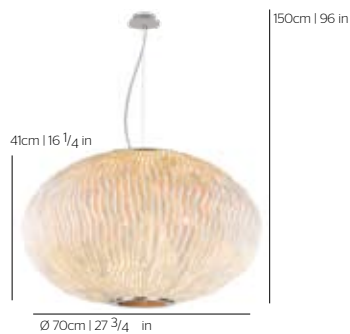

coral seaurchin

by Arturo Álvarez

COAU04G
SILICONA | SILICONE
Un color | One colour



METAL



SOPORTE | FRAME
Tensores
Tie rod

CABLE
Transparente
Transparent

230V - 50Hz

- E27 - Max. 4x23 W
- E27 - Max. 4x23 W
- E27 LED - Max. 4x14 W
- E27 ECO - Max. 4x77 W
- E27 LED - Max. 4x8 W
- E27 - Max. 4x100 W

120V - 60Hz

- E26 Med. - Max. 4x100 W

70x70x40 cm
28x28x16 in
 3.7kg | 8.2lb



pg. 18



curvas

by Arturo Álvarez

CV04G
VIDRIO | GLASS
Un color | One colour



METAL



SOPORTE | FRAME
Tensores
Tie rod

CABLE
Transparente
Transparent

> Difusor superior e inferior
Top and bottom diffuser

230V - 50Hz

- E27 - Max. 4x23 W
- E27 ECO - Max. 4x77 W
- E27 LED - Max. 4x8 W
- E27 - Max. 4x100 W

120V - 60Hz

- E26 Med. - Max. 4x100 W

60x60x30 cm
24x24x12 in
 6.3kg | 13.9lb



pg. 143, 144, 145

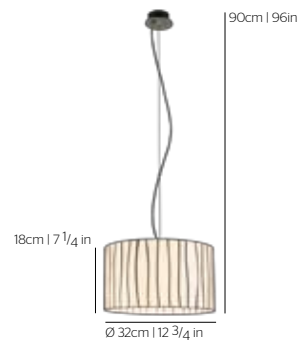

curvas

by Arturo Álvarez

CV04

VIDRIO | GLASS

Un color | One colour



METAL



SOPORTE | FRAME

Tensores

Tie rod

CABLE

Negro o transparente

Black or transparent

230V - 50Hz

E27 - Max. 1x23 W

E27 - Max. 1x23 W

E27 LED - Max. 1x14 W

E27 ECO - Max. 1x77 W

E27 LED - Max. 1x8 W

E27 - Max. 1x100 W

120V - 60Hz

E26 Med. - Max. 1x100 W

42x42x30 cm
17x17x12 in

4.4kg | 6.7lb



pg. 145

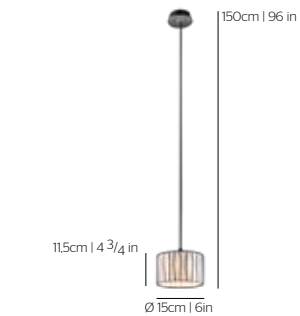

curvas

by Arturo Álvarez

CV04-1

VIDRIO | GLASS

Un color | One colour



METAL



CABLE

Negro o transparente

Black or transparent

230V - 50Hz

E14 - Max. 1x9 W

E14 LED - Max. 1x46 W

E14 LED - Max. 1x5 W

E14 - Max. 1x60 W

120V - 60Hz

E12 Candel - Max. 1x60 W

Mini Spiral - 1x13 W

20x20x20 cm
8x8x8 in

1.7kg | 3.8lb



pg. 145

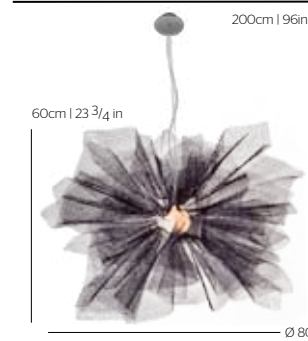

fluo

by Arturo Álvarez

FLO4

ACERO | STEEL

Un color | One colour

* A partir de 5 unidades, elegir color RAL Classic.

For orders of 5 or more units, select any RAL Classic colour.

METAL



SOPORTE | FRAME

Tensores

Tie rod

CABLE

Transparente

Transparent

230V - 50Hz

E27 - Max. 1x23 W

E27 LED - Max. 1x14 W

E27 - Max. 1x100 W

120V - 60Hz

E26 Med. - Max. 1x100 W

80x75x60 cm
32x30x24 in

2kg | 4.41lb



pg. 140



gea

by Arturo Álvarez

GEO4

SILICONA | SILICONE

Un color | One colour



METAL



CABLE

Negro o transparente

Black or transparent

230V - 50Hz

E27 - Max. 1x23 W

E27 ECO - Max. 1x77 W

E27 LED - Max. 1x8 W

E27 - Max. 1x100 W

120V - 60Hz

E26 Med. - Max. 1x100 W

60x25x20 cm
32x30x24 in

2kg | 4.4lb



pg. 69



holes

by Bertjan Pot

HLO4

TYVEK® | TYVEK®



METAL



CABLE

Transparente

Transparent

230v-50HZ

E27 - Max. 1x23 W

E27 - Max. 1x23 W

E27 LED - Max. 1x14 W

E27 ECO - Max. 1x77 W

E27 LED - Max. 1x8 W

E27 - Max. 1x100 W

120V - 60Hz

E26 Med. - Max. 1x100 W

E26 Med. - Max. 1x18 W

42x42x20 cm
17x17x8 in

2kg | 4.4lb



pg. 151



iki

by Arturo Álvarez

IKO4
SILICONA | SILICONE
Un color | One colour



METAL



SOPORTE | FRAME

Tensores
Tie rod

CABLE

Transparente
Transparent

230V - 50Hz

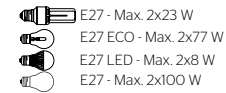

120V - 60Hz



125x31x25 cm
50x13x10 in
6kg | 13.3lb



pg. 106, 108, 109

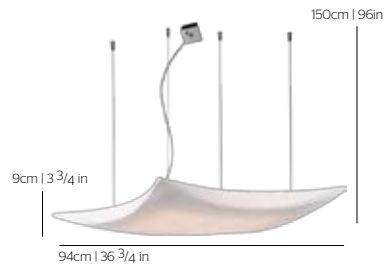

kite

by Arturo Álvarez

KT04G
KT04G-D con regulador | with dimmer
SILICONA | SILICONE
Un color | One colour



METAL



SOPORTE | FRAME

Tensores
Tie rod

CABLE

Transparente
Transparent

230V - 50Hz



Opción bombillas de color
Coloured bulb options



120V - 60Hz

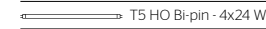

100x100x12 cm
40x40x5 in
9kg | 19.8lb



pg. 80, 81

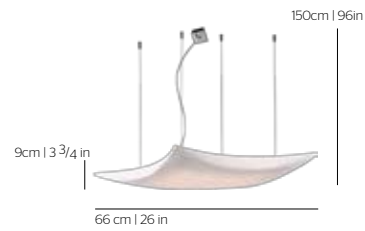

kite

by Arturo Álvarez

KT04
SILICONA | SILICONE
Un color | One colour



METAL



SOPORTE | FRAME

Tensores
Tie rod

CABLE

Transparente
Transparent

230V - 50Hz

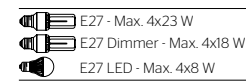

120V - 60Hz



71x71x13 cm
28x28x6 in
3kg | 6.6lb

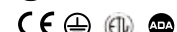

pg. 80, 81

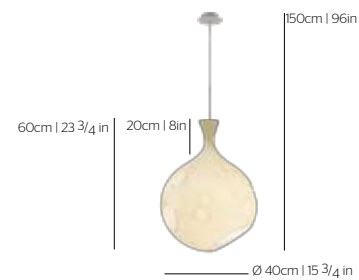

lua

by Martín Azúa

LU04
POLIETILENO | POLYETHYLENE



METAL



CABLE

Transparente
Transparent

230V - 50Hz

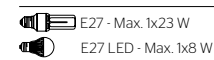

120V - 60Hz

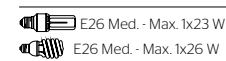

43x43x60 cm
17x17x24 in
4kg | 9lb



pg. 158

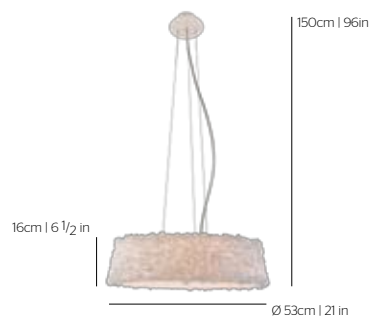

miuu

by Arturo Álvarez

MI04G
MI04G-D con regulador | with dimmer
TELA | FABRIC

Uno o dos colores | One or two colours

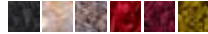

> Difusor superior e inferior
Top and bottom diffuser

METAL



SOPORTE | FRAME

Tensores
Tie rod

CABLE

Transparente
Transparent

230V - 50Hz

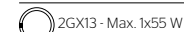

120V - 60Hz

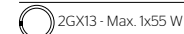

60x60x20 cm
24x24x8 in
6.3kg | 13.9lb



pg. 119



miuu

 by Arturo Álvarez

MIO4
MIO4-D con regulador | with dimmer
TELA | FABRIC

Uno o dos colores | One or two colours

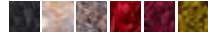

> Difusor superior e inferior
Top and bottom diffuser

METAL

CABLE
Transparente
Transparent

230V - 50Hz
 2GX13 - Max. 1x22 W

120V - 60Hz
 2GX13 - Max. 1x22 W

42x42x20 cm
 2,7kg | 6lb

pg. 114, 117, 118

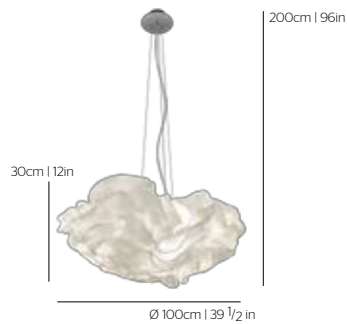

nevo

 by Arturo Álvarez

NEO4G
SILICONA | SILICONE
Un color | One colour



> Incluye Difusor
Diffuser included

> Nota: Las dimensiones de la tulipa indicadas son solo aproximadas y nunca exactas.

Note: The indicated shade dimensions are only approximate, never exact.

METAL

SOPORTE | FRAME
Tensores
Tie rod

CABLE
Transparente
Transparent

230V - 50Hz
 E27 - Max. 4x23 W
 E27 ECO - Max. 4x77 W
 E27 LED - Max. 4x8 W
 E27 - Max. 4x100 W

120V - 60Hz
 E26 Med. - Max. 4x100 W

83x83x37 cm
 7kg | 15,4lb

pg. 28, 29, 30



nevo

 by Arturo Alvarez

NEO4
SILICONA | SILICONE
Un color | One colour



> Incluye Difusor
Diffuser included

> Nota: Las dimensiones de la tulipa indicadas son solo aproximadas y nunca exactas.

Note: The indicated shade dimensions are only approximate, never exact.

METAL

SOPORTE | FRAME
Tensores
Tie rod

CABLE
Transparente
Transparent

230V - 50Hz
 E27 - Max. 3x23 W
 E27 ECO - Max. 3x77 W
 E27 LED - Max. 3x8 W
 E27 - Max. 3x100 W

120V - 60Hz
 E26 Med. - Max. 3x100 W

60x60x20 cm
 24x24x8 in
 4,9kg | 10,8lb

pg. 28, 29, 30

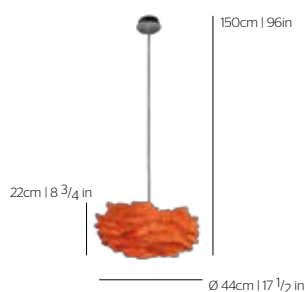

nevo

 by Arturo Álvarez

NEO4-1
SILICONA | SILICONE
Un color | One colour



> Nota: Las dimensiones de la tulipa indicadas son solo aproximadas y nunca exactas.

Note: The indicated shade dimensions are only approximate, never exactly.

METAL

CABLE
Negro o transparente
Black or transparent

230V - 50Hz
 E14 - Max. 2x9 W
 E14 - Max. 2x11 W
 E14 ECO - Max. 2x46 W
 E14 LED - Max. 2x5 W
 E14 - Max. 2x60 W

120V - 60Hz
 E12 Candel - Max. 2x60 W

42x42x20 cm
 17x17x8 in
 2,5kg | 5,5lb

pg. 30



norr

 by Christina Liljenberg

NRO4-A sin difusor, sin madera | no diffuser, no wood
NRO4-B sin difusor, con maderal no diffuser, with wood
NRO4-C con difusor, sin madera | with diffuser, no wood
NRO4-H con difusor y madera | with diffuser and wood

OPCIONES DE LANA | WOOL OPTIONS

Un color | One colour



Dos colores: 1º color (5 paños) y 2º color (1paño)
Two colours: 1st colour (5 pieces) and 2nd colour (1 piece)

METAL

CABLE
Transparente
Transparent

230V - 50Hz
 E27 - Max. 3x23 W
 E27 ECO - Max. 3x77 W
 E27 LED - Max. 3x8 W
 E27 - Max. 3x100 W

120V - 60Hz
 E26 Med. - Max. 3x100 W
 E26 Med. - Max. 3x18 W

80x75x60 cm
 32x30x24 in
 3kg | 6,61lb

pg. 112

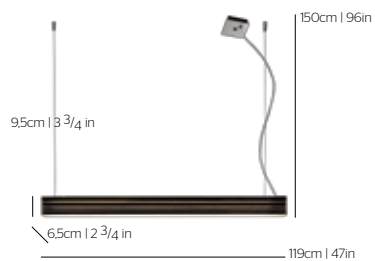

norman

by Arturo Álvarez

NO04

Vidrio | GLASS
Un color | One colour



METAL



SOPORTE | FRAME
Tensores
Tie rod

CABLE

Negro o transparente
Black or transparent

230V - 50Hz

G5 - Max. 1x54 W

120V - 60Hz

T5 HO Bi-pin - 1x54 W

145x20x20 cm
57x8x8 in
6.5kg | 14.3lb



pg. 155

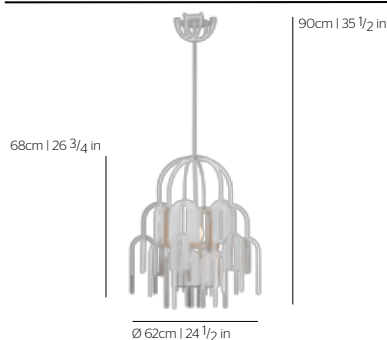

rhizome

by Matali Crasset

RH04

ACERO | STEEL
Amarillo | Yellow Plata | Silver



METAL



> Opciones alturas: 90, 110, 130cm 35 1/2 x 43 1/2 x 51 1/4 in
Different heights available: 90, 110, 130cm 35 1/2 x 43 1/2 x 51 1/4 in

230V - 50Hz

E27 - Max. 1x23 W

E27 LED - Max. 1x14 W

E27 - Max. 1x100 W

120V - 60Hz

E26 Med. - Max. 1x100 W

80x25x25 cm
32x10x10 in
6.5kg | 14.3lb

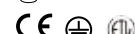

pg. 120



shio

by Arturo Álvarez

SH04

SH04-D con regulador | with dimmer
TABLERO MARINO | PLYWOOD

Un color | One colour



METAL



SOPORTE | FRAME
Tensores
Tie rod

> Difusor superior e inferior
Top and bottom diffuser

230V - 50Hz

2GX13 - Max. 1x55 W

120V - 60Hz

2GX13 - Max. 1x55 W

20x60x60 cm
24x24x8 in
6kg | 13.2lb



pg. 95



shio

by Arturo Álvarez

SH04-1

SH04-1-D con regulador | with dimmer
TABLERO MARINO | PLYWOOD

Un color | One colour



METAL



SOPORTE | FRAME
Tensores
Tie rod

> Difusor superior e inferior
Top and bottom diffuser

230V - 50Hz

2GX13 - Max. 1x22 W

120V - 60Hz

2GX13 - Max. 1x22 W

42x42x20 cm
17x17x8 in
4kg | 8.8lb



pg. 95



tati

by Arturo Álvarez

TA04G

SILICONA | SILICONE
Un color | One colour



> Incluye Difusor
Diffuser included

> Nota: Las dimensiones de la tulipa indicadas son solo aproximadas y nunca exactas.
Note: The indicated shade dimensions are only approximate, never exact.

METAL



SOPORTE | FRAME
Tensores
Tie rod

CABLE

Transparente
Transparent

230V - 50Hz

E27 - Max. 4x23 W

E27 ECO - Max. 4x77 W

E27 LED - Max. 4x8 W

E27 - Max. 4x100 W

120V - 60Hz

E26 Med. - Max. 4x100 W

83x83x37 cm
33x33x15 in
8kg | 17.6lb

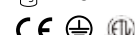

pg. 59, 62, 63



tati

 by Arturo Álvarez

TA04

SILICONA | SILICONE
Un color | One colour



> Incluye Difusor
Diffuser included

> Nota: Las dimensiones de la tulipa indicadas son solo aproximadas y nunca exactas.

Note: The indicated shade dimensions are only approximate, never exact.

METAL



SOPORTE | FRAME

Tensores

Tie rod

CABLE

Transparente
Transparent

230V - 50Hz

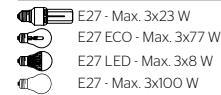

120V - 60Hz



60x60x20 cm
24x24x8 in



4kg | 8.82lb
pg. 58, 59, 62

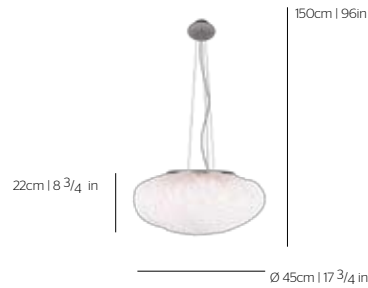

tati

 by Arturo Álvarez

TA04-1

SILICONA | SILICONE
Un color | One colour



> Nota: Las dimensiones de la tulipa indicadas son solo aproximadas y nunca exactas.

Note: The indicated shade dimensions are only approximate, never exact.

METAL



CABLE

Negro o transparente

Black or transparent

230V - 50Hz

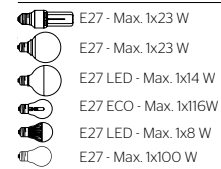

120V - 60Hz

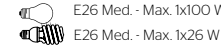

42x42x20 cm
17x17x8 in



3kg | 6.61lb
pg. 58, 59, 62



tina

 by Arturo Álvarez

TN04

POLIPROPILENO | POLYPROPYLENE
Un color | One colour



METAL



CABLE

Negro o transparente

Black or transparent

230V - 50Hz

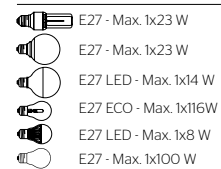

120V - 60Hz

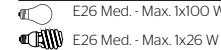

104x31x25 cm
41x13x10 in



3kg | 6.6lb
pg. 101

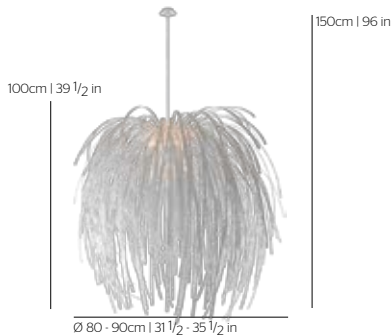

tina

 by Arturo Álvarez

TN04G

POLIPROPILENO | POLYPROPYLENE
Un color | One colour



METAL



CABLE

Negro o transparente

Black or transparent

230V - 50Hz

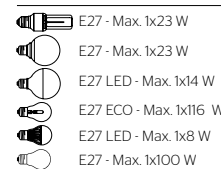

120V - 60Hz

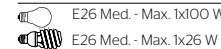

125x31x25 cm
50x13x10 in



3.5kg | 7.7lb
pg. 101



uxi

 by Arturo Álvarez

UX04

UX04-D con regulador | with dimmer
TABLERO MARINO | PLYWOOD

Un color | One colour



> Difusor superior e inferior
Top and bottom diffuser

METAL



SOPORTE | FRAME

Tensores

Tie rod

CABLE

Transparente
Transparent

230V - 50Hz



120V - 60Hz



104x31x25 cm
41x13x10 in



4.8kg | 110.6lb
pg. 136

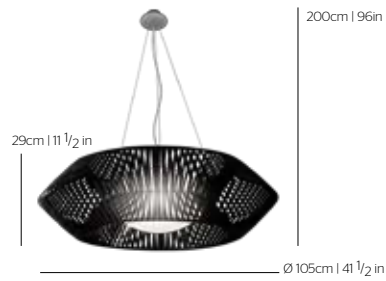

V
by Héctor Serrano

VV04G
POLICARBONATO | POLYCARBONATE
Un color | One colour



> Incluye Difusor
Diffuser included

METAL



SOPORTE | FRAME
Tensores
Tie rod

CABLE
Transparente
Transparent

230V - 50Hz

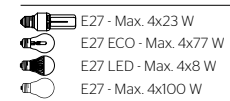

120V - 60Hz

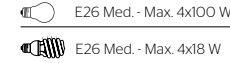

110x110x30 cm | 50x45x30 cm
44x44x12 in | 20x18x12 in



pg. 46, 47

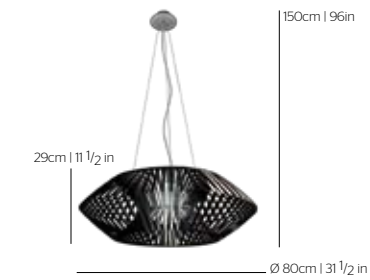

V
by Héctor Serrano

VV04
POLICARBONATO | POLYCARBONATE
Un color | One colour



> Incluye Difusor
Diffuser included

METAL



SOPORTE | FRAME
Tensores
Tie rod

CABLE
Transparente
Transparent

230V - 50Hz

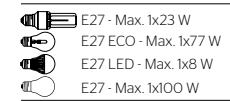

120V - 60Hz



83x83x37 cm
33x33x15 in



pg. 46, 47

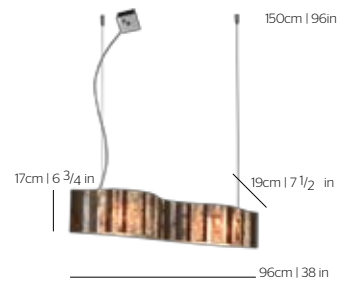

vento
by Arturo Álvarez

VNO4
OPCIONES DE VIDRIO | GLASS OPTIONS
Un color | One colour



METAL



SOPORTE | FRAME
Tensores
Tie rod

CABLE
Transparente
Transparent

230V - 50Hz

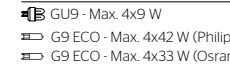

120V - 60Hz

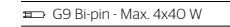

125x31x25 cm
50x13x10 in



pg. 82

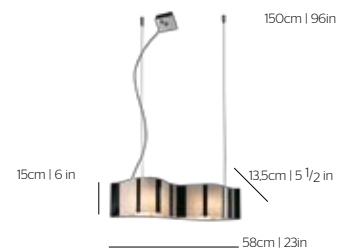

vento
by Arturo Álvarez

VN04-1
OPCIONES DE VIDRIO | GLASS OPTIONS
Un color | One colour



METAL



SOPORTE | FRAME
Tensores
Tie rod

CABLE
Transparente
Transparent

230V - 50Hz

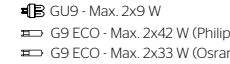

120V - 60Hz

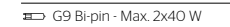

80x30x30 cm
32x12x12 in



pg. 85

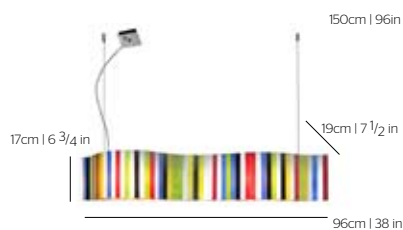

ventopop
by Arturo Álvarez

VNO4POP
OPCIONES DE VIDRIO | GLASS OPTIONS
COMBINACIÓN POP | POP COMBINATION



METAL



SOPORTE | FRAME
Tensores
Tie rod

CABLE
Transparente
Transparent

230V - 50Hz

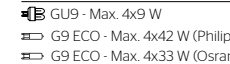

120V - 60Hz

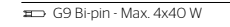

125x31x25 cm
50x13x10 in

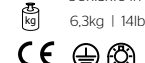

pg. 84

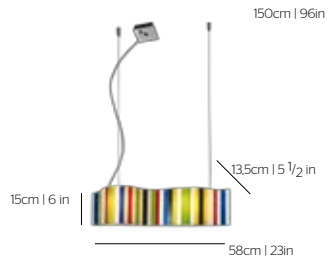

ventopop

by Arturo Álvarez

VN04-1POP
OPCIONES DE VIDRIO | GLASS OPTIONS
Combinación POP | POP combination



METAL



SOPORTE | FRAME

Tensores

Tie rod

CABLE

Transparente

Transparent

230V - 50Hz

E27 - Max. 2x9 W

G9 ECO - Max. 2x42 W (Philips)

G9 ECO - Max. 2x33 W (Osram)

120V - 60Hz

G9 Bi-pin - Max. 2x40 W

80x30x30 cm

32x12x12 in

4.3kg | 9.5lb



pg. 84



woods

by Héctor Serrano

WD04
ABEDUL | BIRCH



> Incluye Difusor
Diffuser included

METAL



CABLE

Transparente

Transparent

230V - 50Hz

E27 - Max. 1x23 W

E27 ECO - Max. 1x77 W

E27 LED - Max. 1x8 W

E27 - Max. 1x100 W

120V - 60Hz

E26 Med. - Max. 1x100 W

E26 Med. - Max. 1x18 W

60x60x30 cm

24x24x12 in

15kg | 33lb



pg. 128, 130, 131

florón cuadrado/square canopy
60x60 cm | 23 3/4 x 23 3/4 in

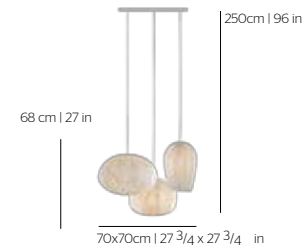

comp. coral 3

by Arturo Álvarez

CO04-3
SILICONA | SILICONE
Un color | One colour



> Ref: COAU04, COSE04, COGA04

CABLE

Transparente

Transparent

230V - 50Hz

E27 - Max. 3x23 W

E27 ECO - Max. 3x77 W

E27 LED - Max. 3x8 W

E27 - Max. 3x100 W

120V - 60Hz

E26 Med. - Max. 3x100 W

E26 Med. - Max. 3x23 W

60x80x82 cm

24x32x33 in

8kg | 17.6lb



pg. 14

florón cuadrado/square canopy
60x60 cm | 23 3/4 x 23 3/4 in

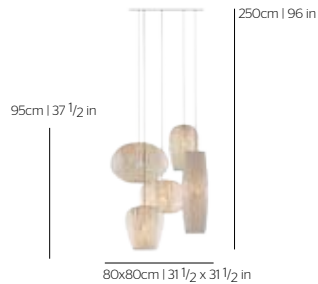

comp. coral 5

by Arturo Álvarez

CO04-5
SILICONA | SILICONE
Un color | One colour



> Ref: COAU04, COCY04, COSE04,
COGA04, CORE04

CABLE

Transparente

Transparent

230V - 50Hz

E27 - Max. 5x23 W

E27 ECO - Max. 5x77 W

E27 LED - Max. 5x8 W

E27 - Max. 5x100 W

120V - 60Hz

E26 Med. - Max. 5x100 W

E26 Med. - Max. 5x23 W

60x80x110 cm

24x32x44 in

12kg | 27lb



pg. 13

florón cuadrado/square canopy
120x120 cm | 47 1/4 x 47 1/4 in

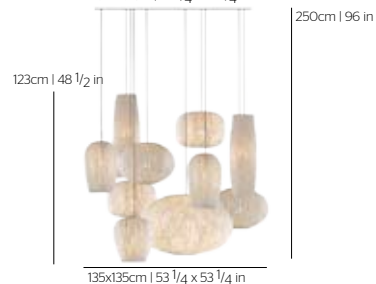

comp. coral 10

by Arturo Álvarez

CO04-10
SILICONA | SILICONE
Un color | One colour



> Ref: 2 COGA04, 2 COSE04, 2 CORE04,
1 COCY04, 2 COAU04, 1 COAU04G

CABLE

Transparente

Transparent

230V - 50Hz

E27 - Max. 13x23 W

E27 ECO - Max. 13x77 W

E27 LED - Max. 13x8 W

E27 - Max. 13x100 W

120V - 60Hz

E26 Med. - Max. 13x100 W

E26 Med. - Max. 13x23 W

120x80x120 cm

48x32x48 in

50kg | 110lb



pg. 16

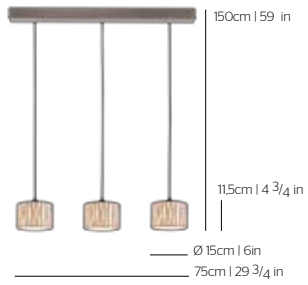

curvas by Arturo Álvarez

CV04-3

VIDRIO | GLASS

Un color | One colour



METAL



CABLE

Negro o transparente
Black or transparent

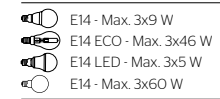

120V - 60Hz

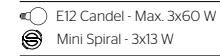

ACERO INOXIDABLE / STAINLESS STEEL



CABLE
Transparente
Transparent



NEGRO / BLACK



CABLE
Negro
Black

CORS by Arturo Álvarez

CR06
SILICONA | SILICONE
Un color | One colour



230V - 50Hz

- GU9 - Max. 2x9 W
- G9 ECO - Max. 2x42 W
- G9 - Max. 2x60 W

120V - 60Hz

- G9 Bi-pin - Max. 2x60 W

50x25x20 cm
20x10x8 in
 1kg | 2.2lb

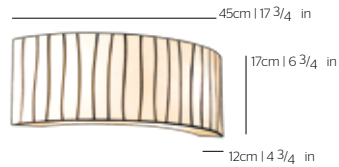

pg. 70, 72, 73

CURVAS by Arturo Álvarez

CV06
VIDRIO | GLASS
Un color | One colour



230V - 50Hz

- E14 - Max. 2x11 W
- E14 ECO - Max. 2x46 W
- E14 LED - Max. 2x5 W
- E14 - Max. 2x60 W

120V - 60Hz

- E12 Candel - Max. 2x60 W
- GX24q-1 4-pin - 2x13 W

60x25x20 cm
24x10x8 in
 2.6kg | 5.8lb

**gea** by Arturo Álvarez

GEO6
SILICONA | SILICONE
Un color | One colour



230V - 50Hz

- GU9 - Max. 2x9 W
- G9 ECO - Max. 2x42 W
- G9 - Max. 2x60 W

120V - 60Hz

- G9 Bi-pin - Max. 2x60 W

36x11x14 cm
15x5x6 in
 1kg | 2.2lb

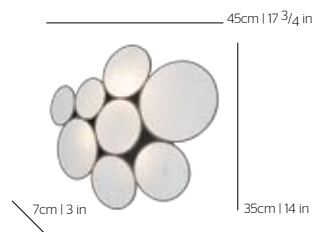

pg. 68

gluc by Arturo Álvarez

GL06
VIDRIO | GLASS
Uno o dos colores | One or two colours



230V - 50Hz

- GU9 - Max. 3x9 W
- G9 ECO - Max. 3x42 W
- G9 - Max. 3x40 W

120V - 60Hz

- G9 Bi-pin - Max. 3x40 W

60x60x30 cm
24x24x12 in
 2.2kg | 4.9lb

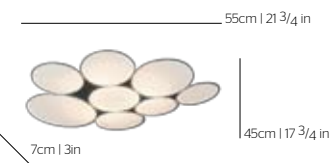

pg. 89, 90, 91

gluc by Arturo Álvarez

GL05
VIDRIO | GLASS
Uno o dos colores | One or two colours



230V - 50Hz

- GU9 - Max. 3x9 W
- G9 ECO - Max. 3x42 W
- G9 - Max. 3x40 W

120V - 60Hz

- G9 Bi-pin - Max. 3x40 W

60x60x30 cm
24x24x12 in
 2.9kg | 6.4lb



pg. 89, 90, 91

Ø 45cm | 17 3/4 in

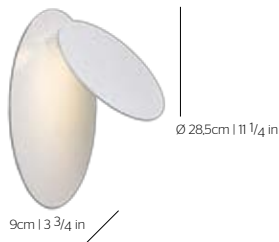

Ø 28,5cm | 11 1/4 in

9cm | 3 3/4 in

guau

by Arturo Álvarez

GU06
DIBOND®



230V - 50Hz

⊕ GX53 - Max. 3x9 W

Opción bombillas de color Coloured bulb options

120V - 60Hz

⊕ GX53 - Max. 3x9 W

50x45x20 cm
20x18x8 in
 5kg | 11lb



pg. 102, 104, 105

www.arturoalvarez.com

Ø 30cm | 12 in



Ø 19cm | 7 1/2 in

9cm | 3 3/4 in

guau

by Arturo Álvarez

GU06P
DIBOND®



230V - 50Hz

⊕ GX53 - Max. 1x13 W

Opción bombillas de color Coloured bulb options

120V - 60Hz

⊕ GX53 - Max. 1x9 W

42x42x20 cm
17x17x8 in
 2kg | 4.4lb



pg. 102, 104, 105

47cm | 18 3/4 in



96cm | 38 in

8cm | 3 1/4 in

27cm | 10 3/4 in

hexa

by Arturo Álvarez

HE06
HE06-D con regulador | with dimmer
SILICONA | SILICONE
Un color | One colour



230V - 50Hz

⚡ G5 - Max. 2x24 W

Opción bombillas de color Coloured bulb options

120V - 60Hz

⚡ T5 HO Bi-pin - 2x24 W

100x50x12 cm
40x20x5 in
 4,5kg | 9,9lb



pg. 138

23cm | 9 1/4 in



25cm | 10 in

15cm | 6 in

kala

by Arturo Álvarez

KL06
SILICONA | SILICONE
Un color | One colour



230V - 50Hz

⊕ GU9 - Max. 2x9 W

⊕ G9 ECO - Max. 2x42 W

⊕ G9 - Max. 2x60 W

120V - 60Hz

⊕ G9 Bi-pin - Max. 2x60 W

33x23x13 cm
13x9x6 in
 1kg | 2,2lb



pg. 76, 77

94cm | 37 in

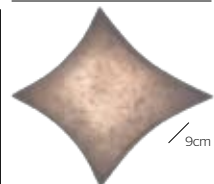

9cm | 3 3/4 in

87cm | 34 1/4 in

kite

by Arturo Álvarez

KT06
SILICONA | SILICONE
Un color | One colour



230V - 50Hz

⊕ E27 - Max. 4x23 W

⊕ E27 Dimmer - Max. 4x18 W

⊕ E27 LED - Max. 4x8 W

120V - 60Hz

⊕ E26 Med. - Max. 4x18 W

71x71x13 cm
28x28x6 in
 3kg | 6,6lb



pg. 79

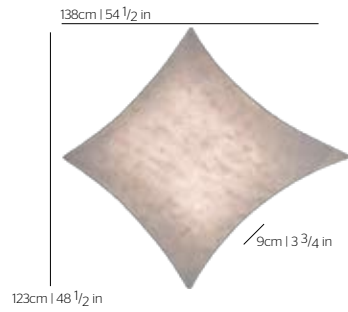

kite

by Arturo Álvarez

KT06G
KT06G-D con regulador | with dimmer
SILICONA | SILICONE

Un color | One colour



230V - 50Hz

G5 - Max. 4x24 W

Opción bombillas de color
Coloured bulb options

120V - 60Hz

T5 HO Bi-pin - 4x24 W

100x100x12 cm
40x40x5 in
 9kg | 19.8lb



pg. 79

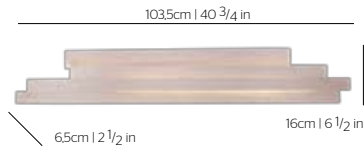

li

by Arturo Álvarez

LI06G
CELULOSA PRENSADA | PRESSED CELLULOSE
Un color | One colour



230V - 50Hz

LED - 1x14.4 W 0,6m/A

120V - 60Hz

Not available

104x31x25 cm
41x13x10 in
 3kg | 6.61lb



pg. 55



li

by Arturo Álvarez

LI06
CELULOSA PRENSADA | PRESSED CELLULOSE
Un color | One colour



230V - 50Hz

LED - 1x7.2 W 0,6m/A

120V - 60Hz

Not available

60x25x20 cm
24x10x8 in
 1.5kg | 3.31lb



pg. 52, 54, 56, 57



miuu

by Arturo Álvarez

MI06
MI06-D con regulador | with dimmer
TELA | FABRIC

Uno o dos colores | One or two colours

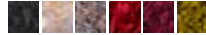

230V - 50Hz

2GX13 - Max. 1x55 W

120V - 60Hz

2GX13 - Max. 1x55 W

60x50x14 cm
24x20x6 in
 3kg | 6.6lb



pg. 117

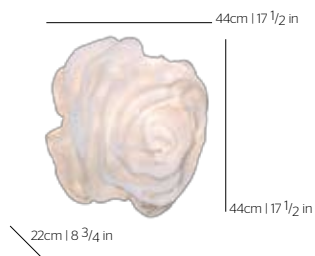

nevo

by Arturo Álvarez

NE06
SILICONA | SILICONE
Un color | One colour



> Nota: Las dimensiones de la tulipa indicadas son solo aproximadas y nunca exactas.

Note: The indicated shade dimensions are only approximate, never exact.

230V - 50Hz

E14 - Max. 2x9 W

E14 ECO - Max. 2x46 W

E14 LED - Max. 2x5 W

E14 - Max. 2x60 W

120V - 60Hz

E12 Candel - Max. 2x60 W

42x42x20 cm
17x17x8 in
 2.4kg | 5.3lb



pg. 33

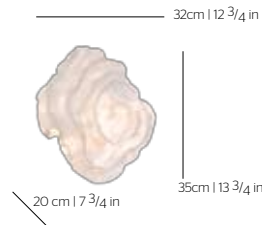

nevo

 by Arturo Álvarez

NEO6P
SILICONA | SILICONE
Un color | One colour



> Nota: Las dimensiones de la tulipa indicadas son solo aproximadas y nunca exactas.
Note: The indicated shade dimensions are only approximate, never exact.

230V - 50Hz

GU9 - Max. 1x9 W
G9 ECO - Max. 1x42 W
G9 - Max. 1x60 W

120V - 60Hz

G9 Bi-pin - Max. 1x60 W

42x42x20 cm
17x17x8 in
1kg | 2.2lb



pg. 33

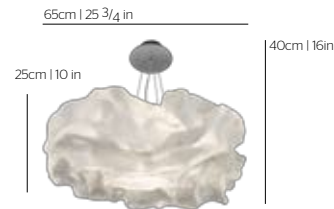

nevo

 by Arturo Álvarez

NEO4 (Uso Plafón | Ceiling use)
SILICONA | SILICONE
Un color | One colour



> Incluye Difusor
Diffuser included
> Nota: Las dimensiones de la tulipa indicadas son solo aproximadas y nunca exactas.
Note: The indicated shade dimensions are only approximate, never exact.

METAL



SOPORTE | FRAME
Tensores
Tie rod

CABLE

Transparente
Transparent

230V - 50Hz

E27 - Max. 3x23 W
E27 ECO - Max. 3x77 W
E27 LED - Max. 3x8 W
E27 - Max. 3x100 W

120V - 60Hz

E26 Med. - Max. 3x100 W

60x60x20 cm
24x24x8 in
4.9kg | 10.8lb

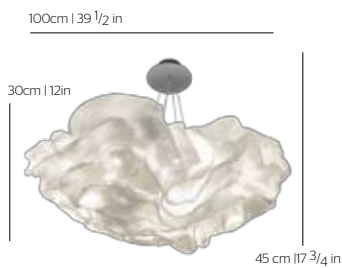

nevo

 by Arturo Álvarez

NEO4G (Uso Plafón | Ceiling use)
SILICONA | SILICONE
Un color | One colour



> Incluye Difusor
Diffuser included
> Nota: Las dimensiones de la tulipa indicadas son solo aproximadas y nunca exactas.
Note: The indicated shade dimensions are only approximate, never exact.

METAL



SOPORTE | FRAME
Tensores
Tie rod

CABLE

Transparente
Transparent

230V - 50Hz

E27 - Max. 4x23 W
E27 ECO - Max. 4x77 W
E27 LED - Max. 4x8 W
E27 - Max. 4x100 W

120V - 60Hz

E26 Med. - Max. 4x100 W

83x83x37 cm
33x33x15 in
7kg | 15.4lb



norman

 by Arturo Álvarez

NO06
VIDRIO | GLASS
Un color | One colour



230V - 50Hz

G5 - Max. 1x54 W

120V - 60Hz

T5 HO Bi-pin - 1x54 W

145x20x20 cm
57x8x8 in
5kg | 11lb



pg. 154

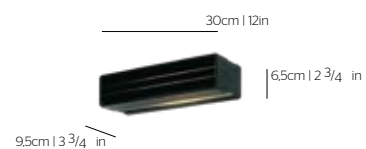

norman

 by Arturo Álvarez

NO06P
VIDRIO | GLASS
Un color | One colour



230V - 50Hz

G24d2 - Max. 1x18 W

120V - 60Hz

GX24q-2 4-pin - 1x18 W

36x11x14 cm
15x5x6 in
1.5kg | 3.3lb



pg. 154

96x96cm | 38 x 38 in



8cm | 3 1/4 in

planum

by Arturo Álvarez

PMO6R
PMO6R-D con regulador | with dimmer
 SILICONA | SILICONE
 Un color | One colour



230V - 50Hz

G5 - Max. 4x24 W

Opción bombillas de color
 Coloured bulb options

120V - 60Hz

T5 HO Bi-pin - 4x24 W

100x100x12 cm
 40x40x5 in
 9kg | 19.8lb



pg. 35, 36, 37, 38, 39

47cm | 18 3/4 in



8cm | 3 1/4 in

96cm | 38 in

planum

by Arturo Álvarez

PMO6PR
PMO6PR-D con regulador | with dimmer
 SILICONA | SILICONE
 Un color | One colour



230V - 50Hz

G5 - Max. 2x24 W

Opción bombillas de color
 Coloured bulb options

120V - 60Hz

T5 HO Bi-pin - 2x24 W

100x50x12 cm
 40x20x5 in
 4.5kg | 9.9lb



pg. 36, 37, 38

shio

by Arturo Álvarez

SH06
SH06-D con regulador | with dimmer
 TABLERO MARINO | PLYWOOD
 Un color | One colour

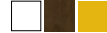

> Difusor superior e inferior
 Top and bottom diffuser

230V - 50Hz

G24q2 - Max. 2x18 W

120V - 60Hz

GX24q-2 4-pin - 2x18 W

60x25x20 cm
 24x10x8 in
 2.4kg | 5.3lb



pg. 96

49cm | 19 1/2 in



10cm | 4 in

16.5cm | 6 1/2 in

tati

by Arturo Álvarez

TA06G
 SILICONA | SILICONE
 Un color | One colour



> Nota: Las dimensiones de la tulipa indicadas son solo aproximadas y nunca exactas.

Note: The indicated shade dimensions are only approximate, never exact.

230V - 50Hz

E14 - Max. 2x9 W
 E14 ECO - Max. 2x46 W
 E14 LED - Max. 2x5 W
 E14 - Max. 2x60 W

120V - 60Hz

E12 Candel - Max. 2x60 W

42x42x20 cm
 17x17x8 in
 2.4kg | 5.3lb



pg. 61

40cm | 15 3/4 in



22cm | 8 3/4 in

40cm | 15 3/4 in

tati

by Arturo Álvarez

TA06
 SILICONA | SILICONE
 Un color | One colour



> Nota: Las dimensiones de la tulipa indicadas son solo aproximadas y nunca exactas.

Note: The indicated shade dimensions are only approximate, never exact.

230V - 50Hz

GU9 - Max. 2x9 W
 G9 ECO - Max. 2x42 W
 G9 - Max. 2x60 W

120V - 60Hz

G9 Bi-pin - Max. 2x60 W

33x23x13 cm
 13x9x6 in
 1kg | 2.2lb



pg. 61

20cm | 8 in



13cm | 5 1/4 in

22cm | 8 3/4 in



tati

by Arturo Álvarez

TA06P
SILICONA | SILICONE
Un color | One colour



> Nota: Las dimensiones de la tulipa indicadas son solo aproximadas y nunca exactas.

Note: The indicated shade dimensions are only approximate, never exact.

230V - 50Hz

GU9 - Max. 1x9 W

G9 ECO - Max. 1x42 W

G9 - Max. 1x60 W

120V - 60Hz

G9 Bi-pin - Max. 1x60 W

42x42x20 cm
17x17x8 in

1kg | 2.2lb



pg. 61

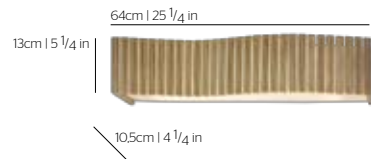

u.xi

by Arturo Álvarez

UX06
UX06-D con regulador | with dimmer
TABLERO MARINO | PLYWOOD

Un color | One colour



> Difusor superior e inferior
Top and bottom diffuser

230V - 50Hz

G5 - Max. 2x24 W

120V - 60Hz

T5 HO Bi-pin - 2x24 W

80x22x25 cm
32x9x10 in

2.4kg | 5.3lb



pg. 137

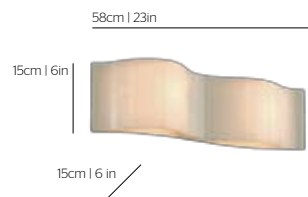

vento

by Arturo Álvarez

VN06
OPCIONES DE VIDRIO | GLASS OPTIONS
Un color | One colour



Malval/Mauve Marrón/Brown B&N|B&W



230V - 50Hz

GU9 - Max. 2x9 W

G9 ECO - Max. 2x42 W (Philips)

G9 ECO - Max. 2x33 W (Osram)

120V - 60Hz

G9 Bi-pin - Max. 2x40 W

80x30x30 cm
32x12x12 in

4.4kg | 9.7lb



pg. 85

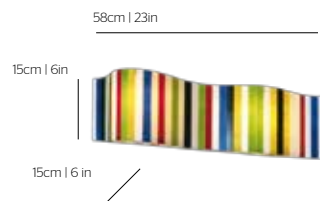

ventopop

by Arturo Álvarez

VN06POP
OPCIONES DE VIDRIO | GLASS OPTIONS
Combinación POP | POP combination



230V - 50Hz

GU9 - Max. 2x9 W

G9 ECO - Max. 2x42 W (Philips)

G9 ECO - Max. 2x33 W (Osram)

120V - 60Hz

G9 Bi-pin - Max. 2x40 W

80x30x30 cm
32x12x12 in

4.4kg | 9.7lb



Apéndice

Appendix

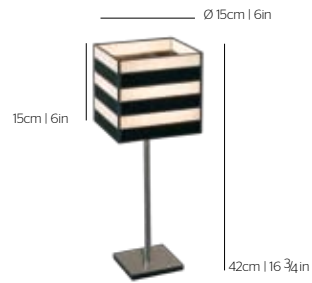

cebra

by Arturo Álvarez

CE01
VIDRIO | GLASS
Uno o dos colores | One or two colours



METAL



CABLE
Negro o transparente
Black or transparent

230V - 50Hz

- E14 - Max. 1x9 W
- E14 - Max. 1x11 W
- E14 ECO - Max. 1x46 W
- E14 LED - Max. 1x5 W
- E14 - Max. 1x60 W

120V - 60Hz

- E12 Candel - Max. 1x60 W

35x25x25 cm
 2,4kg | 5,3lb



doscubos

by Arturo Álvarez

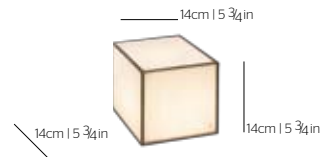

DO01G
VIDRIO | GLASS
Un color | One colour



CABLE

Negro o transparente
Black or transparent

230V - 50Hz

- GU9 - Max. 1x9 W
- G9 ECO - Max. 1x42 W
- G9 - Max. 1x60 W

120V - 60Hz

- G9 Bi-pin - Max. 1x60 W
- Mini Spiral - 1x13 W

20x20x20 cm
 1,7kg | 3,8lb

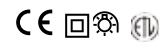

doscubos

by Arturo Álvarez

DO02
VIDRIO | GLASS
Un color | One colour



METAL



CABLE
Negro o transparente
Black or transparent

230V - 50Hz

- GU9 - Max. 2x9 W
- G9 ECO - Max. 2x42 W
- G9 - Max. 2x40 W

120V - 60Hz

- G9 Bi-pin - Max. 2x40 W

60x20x30 cm
 4,1kg | 9,1lb

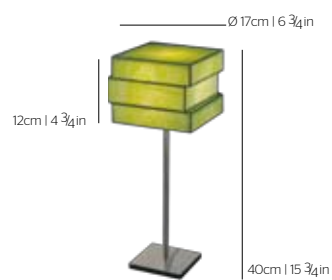

encaixe

by Arturo Álvarez

EN01
VIDRIO | GLASS
Un color | One colour



METAL



CABLE
Negro o transparente
Black or transparent

230V - 50Hz

- E14 - Max. 1x9 W
- E14 ECO - Max. 1x46 W
- E14 LED - Max. 1x5 W
- E14 - Max. 1x60 W

120V - 60Hz

- E12 Candel - Max. 1x60 W

35x25x25 cm
 2,6kg | 5,8lb



senda

by Arturo Álvarez

SN01
VIDRIO | GLASS
Un color | One colour



METAL



CABLE
Negro o transparente
Black or transparent

230V - 50Hz

- E14 - Max. 1x9 W
- E14 - Max. 1x11 W
- E14 ECO - Max. 1x46 W
- E14 LED - Max. 1x5 W
- E14 - Max. 1x60 W

120V - 60Hz

- E12 Candel - Max. 1x60 W

35x25x25 cm
 2,3kg | 5,1lb





sophi

by Arturo Álvarez

SP01
OPCIONES DE VIDRIO | GLASS OPTIONS
Un color | One colour

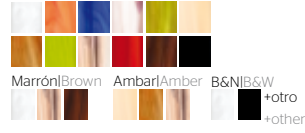

CABLE
Negro o transparente
Black or transparent

230V - 50Hz

- E14 - Max. 1x9 W
- E14 - Max. 1x7 W
- E14 ECO - Max. 1x46 W
- E14 LED - Max. 1x5 W
- E14 - Max. 1x60 W

120V - 60Hz

- E12 Candel - Max. 1x60 W

50x20x25 cm
20x8x10 in
 2.6kg | 5.8lb



dos cubos

by Arturo Álvarez

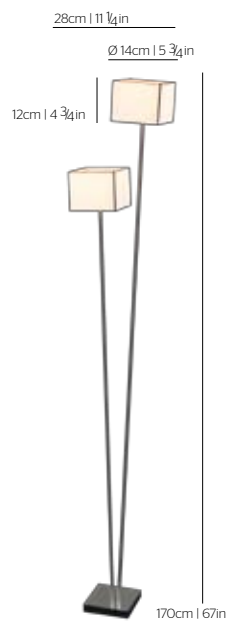

DO03
VIDRIO | GLASS
Un color | One colour



METAL **CABLE**
Negro o transparente
Black or transparent

230V - 50Hz

- E14 - Max. 2x9 W
- E14 ECO - Max. 2x46 W
- E14 LED - Max. 2x5 W
- E14 - Max. 2x60 W

120V - 60Hz

- E12 Candel. - Max. 2x60 W

170x20x20cm | 35x25x25cm
67x8x8in | 14x10x10in

17kg | 37.5lb



encaixe

by Arturo Álvarez

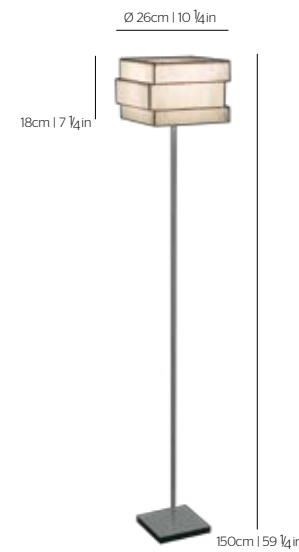

EN03
VIDRIO | GLASS
Un color | One colour



METAL **CABLE**
Negro o transparente
Black or transparent

230V - 50Hz

- E27 - Max. 1x15W
- E27 ECO - Max. 1x77 W
- E27 LED - Max. 1x8 W
- E27 - Max. 1x100 W

120V - 60Hz

- E26 Med. - Max. 1x100 W

145x20x20cm | 42x42x30cm
57x8x8in | 17x17x12in

11kg | 24.3lb



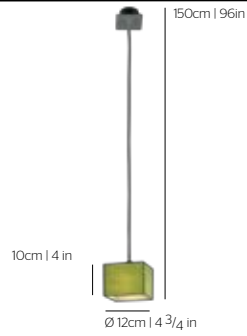

doscubos

by Arturo Álvarez

DO04-1

VIDRIO | GLASS
Un color | One colour



METAL



CABLE

Negro o transparente
Black or transparent

230V - 50Hz

- E14 - Max. 1x9 W
- E14 ECO - Max. 1x46 W
- E14 LED - Max. 1x5W
- E14 - Max. 1x60 W

120V - 60Hz

- E12 Candel - Max. 1x60 W

20x20x20 cm
8x8x8 in
 1kg | 2.2lb

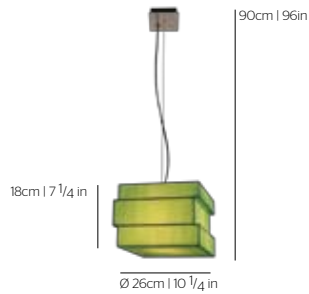

encaixe

by Arturo Álvarez

EN04

VIDRIO | GLASS
Un color | One colour



METAL



SOPORTE | FRAME

Tensores
Tie rod

CABLE

Negro o transparente
Black or transparent

230V - 50Hz

- E27 - Max. 1x15 W
- E27 ECO - Max. 1x77 W
- E27 LED - Max. 1x8 W
- E27 - Max. 1x100 W

120V - 60Hz

- E26 Med. - Max. 1x100 W

42x42x30 cm
17x17x12 in
 4.3kg | 9.5lb

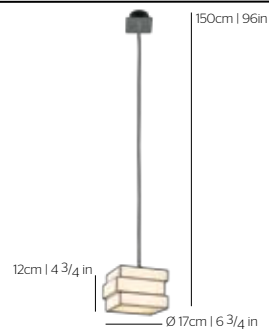

encaixe

by Arturo Álvarez

EN04-1

VIDRIO | GLASS
Un color | One colour



METAL



CABLE

Negro o transparente
Black or transparent

230V - 50Hz

- E14 - Max. 1x9 W
- E14 ECO - Max. 1x46 W
- E14 LED - Max. 1x5 W
- E14 - Max. 1x60 W

120V - 60Hz

- E12 Candel - Max. 1x60 W

35x25x25 cm
14x10x10 in
 1.8kg | 4lb

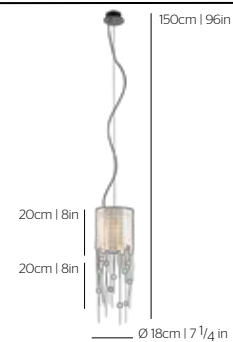

gilda

by Arturo Álvarez

GDO4-1B

MOSAICO BISAZZA™ | BISAZZA™ MOSAIC



METAL



SOPORTE | FRAME

Tensores
Tie rod

Cable

Cable transparente
Transparent

230V - 50Hz

- E14 - Max. 1x9 W
- E14 - Max. 1x11 W
- E14 ECO - Max. 1x46 W
- E14 LED - Max. 1x5 W
- E14 - Max. 1x60 W

120V - 60Hz

- E12 Candel - Max. 1x60 W

35x25x25 cm
14x10x10 in
 2.4kg | 5.3lb

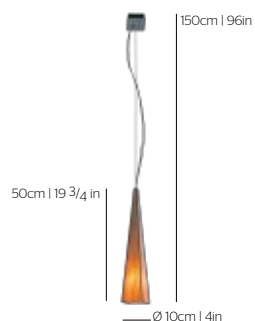

kono

by Arturo Álvarez

KNO4-1

VIDRIO | GLASS
Un color | One colour



METAL



SOPORTE | FRAME

Tensores
Tie rod

CABLE

Transparente
Transparent

230V - 50Hz

- E14 - Max. 1x11 W
- E14 ECO - Max. 1x46W
- E14 LED - Max. 1x5 W
- E14 - Max. 1x60 W

120V - 60Hz

- E12 Candel - Max. 1x60 W

60x25x20 cm
24x10x8 in
 2.2kg | 4.9lb



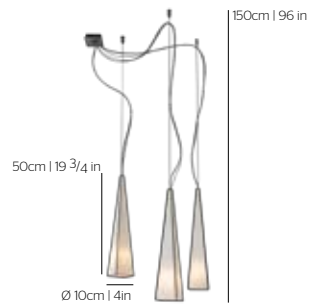

kono

by Arturo Álvarez

KN04-3

VIDRIO | GLASS

Un color | One colour



METAL



SOPORTE | FRAME

Tensores

Tie rod

CABLE

Transparente

Transparent

230V - 50Hz

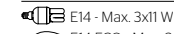

E14 - Max. 3x11 W



E14 ECO - Max. 3x46 W

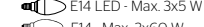

E14 LED - Max. 3x5 W

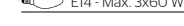

E14 - Max. 3x60 W

120V - 60Hz



E12 Candel - Max. 3x60 W



60x30x20 cm

24x12x8 in



4,5kg | 10lb

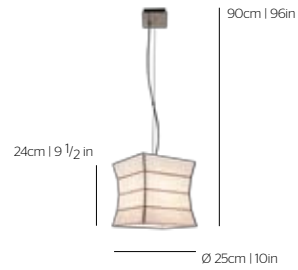

senda

by Arturo Álvarez

SN04

VIDRIO | GLASS

Un color | One colour



METAL



SOPORTE | FRAME

Tensores

Tie rod

CABLE

Negro o transparente

Black or transparent

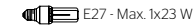

E27 - Max. 1x23 W



E27 - Max. 1x23 W



E27 LED - Max. 1x14 W



E27 ECO - Max. 1x77 W



E27 LED - Max. 1x8 W

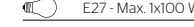

E27 - Max. 1x100 W

120V - 60Hz



E26 Med. - Max. 1x100 W



42x42x30 cm

17x17x12 in



3,4kg | 7,5lb



45cm | 17 3/4 in

19cm | 7 1/2 in



12cm | 4 3/4 in

sophi

by Arturo Álvarez

SPO6B

OPCIONES DE VIDRIO | GLASS OPTIONS

Un color | One colour



Marrón | Brown Ambar | Amber B&N | B&W
+otro
+other

MADERA | WOOD



> Incluye Difusor

Diffuser included

230V - 50Hz



E14 ECO - Max. 2x46 W



E14 LED - Max. 2x5 W

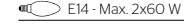

E14 - Max. 2x60 W

120V - 60Hz



E12 Candel - Max. 2x60 W



50x45x30 cm

20x18x12 in



3kg | 6,6lb



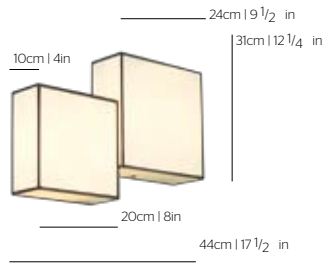

apliques

by Arturo Álvarez

A0501
VIDRIO | GLASS
Un color | One colour



230V - 50Hz

G24d1 - Max. 4x13 W

120V - 60Hz

GX24q-1 4-pin - 4x13 W

50x45x20 cm
20x18x8 in
6.2kg | 13.7lb



apliques

by Arturo Álvarez

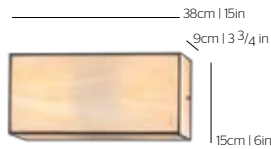

A0604
VIDRIO | GLASS
Un color | One colour



230V - 50Hz

E14 - Max. 2x11 W

E14 ECO - Max. 2x46 W

E14 LED - Max. 2x5 W

E14 - Max. 2x60 W

120V - 60Hz

E12 Candel - Max. 2x60 W

50x20x25 cm
20x8x10 in
1.5kg | 3.31lb



doscubos

by Arturo Álvarez

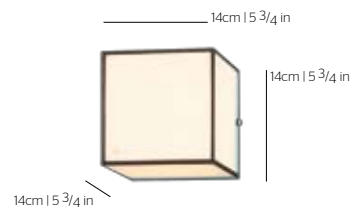

D006G
VIDRIO | GLASS
Un color | One colour



230V - 50Hz

GU9 - Max. 1x9 W

G9 ECO - Max. 1x33 W

G9 - Max. 1x40 W

120V - 60Hz

G9 Bi-pin - Max. 1x40 W

20x20x20 cm
8x8x8 in
1.7kg | 3.8lb



gilda

by Arturo Álvarez

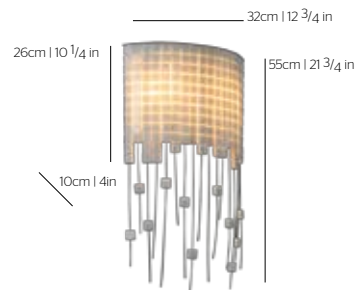

GD06-BB
MOSAICO BISAZZA™ | BISAZZA™ MOSAIC

METAL

230V - 50Hz

G24d2 - Max. 2x18 W

120V - 60Hz

GX24q-2 4-pin - 2x18 W

42x42x20 cm
17x17x8 in
4kg | 8.9lb



sombras

by Arturo Álvarez

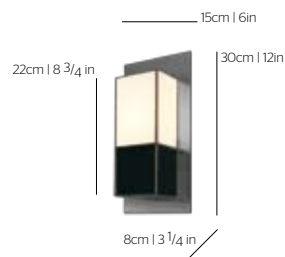

S006
VIDRIO | GLASS
Uno o dos colores | One or two colours



METAL

230V - 50Hz

G24d1 - Max. 1x13W

120V - 60Hz

E12 Candel - Max. 1x60 W

G24q-14-pin - Max. 1x13W

35x25x25 cm
14x10x10 in
1.9kg | 4.2lb



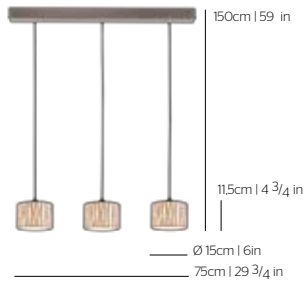

curvas

by Arturo Álvarez

CV04-3
VIDRIO | GLASS
Un color | One colour



METAL



CABLE

Negro o transparente
Black or transparent

230V - 50Hz

- E14 - Max. 3x9 W
- E14 ECO - Max. 3x46 W
- E14 LED - Max. 3x5 W
- E14 - Max. 3x60 W

120V - 60Hz

- E12 Candel - Max. 3x60 W

80x25x25 cm
32x10x10 in
 5,3kg | 11,7lb

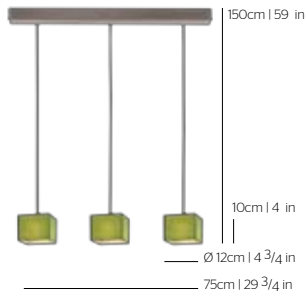

doscubos

by Arturo Álvarez

DO04-3
Vidrio | GLASS
Un color | One colour



METAL



CABLE

Negro o transparente
Black or transparent

230V - 50Hz

- E14 - Max. 3x9 W
- E14 ECO - Max. 3x46 W
- E14 LED - Max. 3x5 W
- E14 - Max. 3x60 W

120V - 60Hz

- E12 Candel - Max. 3x60 W

80x25x25 cm
32x10x10 in
 4,8kg | 10,6lb

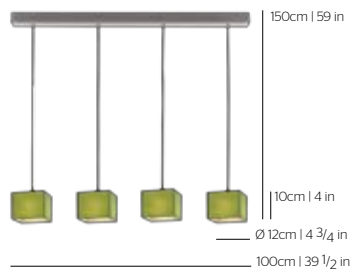

doscubos

by Arturo Álvarez

DO04-4
VIDRIO | GLASS
Un color | One colour



METAL



CABLE

Negro o transparente
Black or transparent

230V - 50Hz

- E14 - Max. 4x9 W
- E14 ECO - Max. 4x46 W
- E14 LED - Max. 4x5 W
- E14 - Max. 4x60 W

120V - 60Hz

- E12 Candel - Max. 4x60 W

104x31x25 cm
41x13x10 in
 6,6kg | 14,6lb

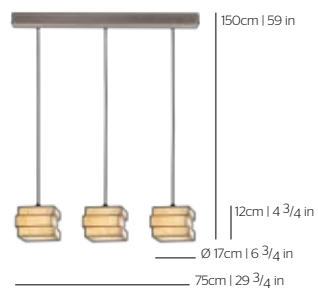

encaixe

by Arturo Álvarez

EN04-3
VIDRIO | GLASS
Un color | One colour



METAL



CABLE

Negro o transparente
Black or transparent

230V - 50Hz

- E14 - Max. 3x9 W
- E14 ECO - Max. 3x46 W
- E14 LED - Max. 3x5 W
- E14 - Max. 3x60 W

120V - 60Hz

- E12 Candel - Max. 3x60 W

80x25x25 cm
32x10x10 in
 6,4kg | 14,1lb

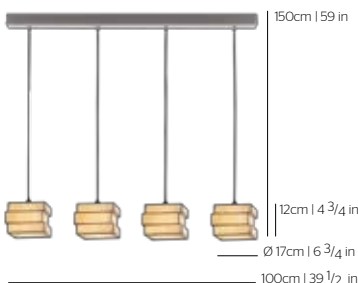

encaixe

by Arturo Álvarez

EN04-4
Vidrio | GLASS
Un color | One colour



METAL



CABLE

Negro o transparente
Black or transparent

230V - 50Hz

- E14 - Max. 4x9 W
- E14 ECO - Max. 4x46 W
- E14 LED - Max. 4x5 W
- E14 - Max. 4x60 W

120V - 60Hz

- E12 Candel - Max. 4x60 W

104x31x25 cm
41x13x10 in
 8,3kg | 18,3lb





Con toma de tierra.
With ground devices.



Doble aislamiento y/o aislamiento reforzado en cada parte y sin toma de tierra.

Double insulation and/or reinforced insulation in every part and without ground devices.



Aparato no adaptado para la instalación en superficies normalmente inflamables.

The device is not suitable for installation on normally inflammable surface.



Luminaria diseñada para usar lámparas halógenas de wolframio con pantalla de protección propia.

Luminaire to use with tungsten halogen bulbs with own protection shield.



These items comply with the Americans with Disabilities Act.



For the USA, these items comply with the UL standard for Luminaires for dry locations under the UL file of Calor Color S.L.



Luminaria homologada, cumple con la normativa CE.

Fitting is legally approved and comply with the European Mark CE.



Premio otorgado por The Chicago Athenaeum: Museo de Arquitectura y Diseño.

As awarded by The Chicago Athenaeum: Museum of Architecture and Design.



Premio otorgado por Design Zentrum Nordrhein Westfalen.

As awarded by the Design Zentrum Nordrhein Westfalen.



Los productos de este catálogo son reproducciones fotográficas impresas. Es posible que el color de las imágenes varíe ligeramente con respecto al color real.

Todas nuestras luminarias están hechas íntegramente a mano en España.

Las diferencias entre ellas y en los distintos materiales empleados convierten a cada lámpara en única. Pequeñas diferencias entre lámparas de una misma referencia no son un defecto, sino un valor, cada una es un objeto único.

Manteniendo las características básicas de los diseños, Arturo Alvarez se reserva el derecho a realizar las modificaciones que considere oportunas con el fin de mejorarlos.

Los componentes electrónicos ofrecen una garantía conforme a la legislación nacional aplicable (ej., 2 años en España).

Las medidas en pulgadas son aproximadas.

The products in this catalogue are printed photographic reproductions. The colour of the pictures may slightly differ from the real colour.

All our lamps are totally handmade in Spain.

The differences found in our luminaires and in the different materials used make them unique. Small differences between lamps are not a defect, it is a value because each one is a unique object.

While maintaining the basic characteristics of the product, Arturo Alvarez reserves the right to make any modifications at any time with the sole aim of improvement.

Electronic components have guarantee according to the national applicable regulations (e.g., 2 years in Spain).

US / Imperial measurements in approximate inches.



Calor Color S.L.
San Miguel de Sarandón, 9
E-15885 Vedra (A Coruña) Spain
T. +34 981 814 600
F. +34 981 502 000
calor-color@arturo-alvarez.com
www.arturo-alvarez.com

© 2013 Calor color S.L.
Todos los derechos reservados
Depósito legal: C 461-2013

Realización y producción:
Calor Color, s.l., Arturo Álvarez
Impresión: Galicia Editorial

© 2013 Calor color S.L.
All Rights reserved
Legal deposit: C 461-2013

Development and production:
Calor Color s.l., Arturo Álvarez
Printing: Galicia Editorial

Agradecimientos Acknowledgments:
Escola de Arte e Superior de Deseño
Mestre Mateo de Santiago de Compostela
www.easd.es, d-due.com, antoniooptica.
es, La cantina www.cidadedacultura.org,
laindustrialbar.com, estudionomada.es,
anavedevidan.com, labulanxeri.es.

